

2026
FİYAT
LİSTESİ

inoled 

inoled 



2013 yılında kurulmuş olan İNOLED AYDINLATMA A.Ş., aydınlatma sektöründe faaliyet göstermektedir. Enerji tasarruflu LED ürünlerin ithalatı, üretimi ve pazarlanması konusunda uzmanlaşmış olan firmamız; "İNOLED" markası ile sektöre yüksek kaliteli, standartlara uygun, uzun ömürlü ve güvenli ürünler sunmaktadır.

Firmamız, Türkiye geneline yayılmış güçlü satış ve hizmet ağıyla ürünlerini siz değerli müşterilerimize ulaştırmaktadır. Yenilik odaklı ürün gruplarına, kaliteye ve kullanıcı memnuniyetine verdiğimiz önemle birlikte, müşterilerimizin ihtiyaçlarına en uygun çözümleri sunmak ve uzun vadeli bir memnuniyet sağlamak için çalışmalarımızı sürdürüyoruz.

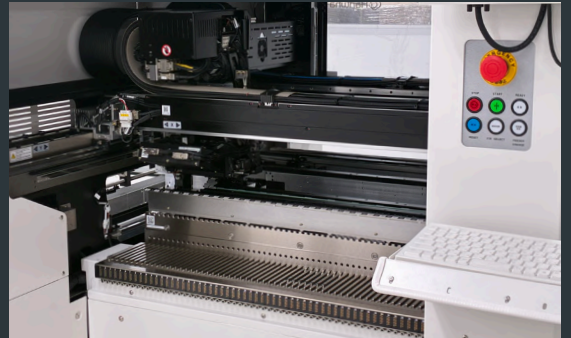
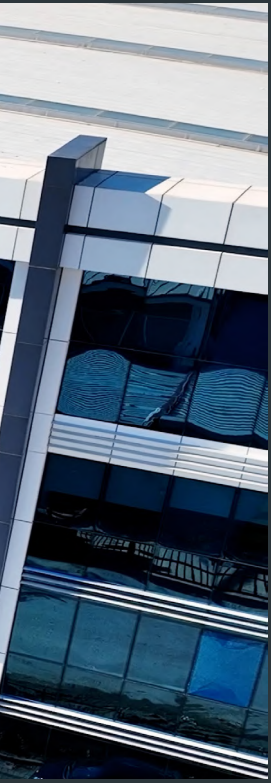

Aydınlatma Laboratuvarımızda;

IESNA LM-79-08 standardına uygun ürün ışık çıktısı ile ilgili elektriksel ve fotometrik ölçümler,

TS EN IEC62384, TS EN IEC 61000-3-2 standartlarına göre LED Driver testleri,

TS EN IEC 60598 standardına göre aydınlatma armatürleri için dayanıklılık deneyi ve elektriksel güvenlik testleri,

Ürün genelinde ISO9001 kalite yönetim sistemine uygun giriş, proses ve son kontrol testleri yapılmaktadır.

Ürün Görseli Ürün Kodu Sayfa Fiyat



4250	11	20,00 USD
4256	11	29,00 USD
4258	11	50,00 USD
4260	12	20,00 USD
4274	11	29,50 USD
4284	12	31,00 USD
4470	13	33,00 USD
4474	13	51,00 USD
4476	13	48,00 USD
4478	13	71,00 USD



4664	16	36,00 USD
4670	15	33,00 USD
4674	15	65,00 USD
4676	15	60,00 USD
4678	15	98,00 USD
4684	16	67,00 USD
4880	17	39,00 USD
4884	17	76,00 USD
4886	17	67,00 USD
4888	17	107,00 USD



3702	19	19,50 USD
3704	19	23,00 USD
3706	19	25,50 USD
3708	19	30,50 USD
3710	19	39,00 USD
3712	19	42,00 USD
120201	20	13,00 USD
120202	20	17,00 USD
120203	20	20,00 USD
120204	20	23,00 USD



2502	21	7,50 USD
2504	21	11,00 USD
2506	21	15,00 USD

Ürün Görseli Ürün Kodu Sayfa Fiyat



2703	22	4,30 USD
2706	22	5,30 USD
2709	22	7,50 USD
2712	22	8,30 USD
2715	22	9,60 USD
2718	22	10,30 USD
2724	22	18,50 USD
2803	23	4,80 USD
2806	23	6,00 USD
2809	23	8,30 USD
2812	23	9,20 USD
2815	23	10,70 USD
2818	23	11,50 USD
2824	23	20,00 USD



2750	24	11,20 USD
2751	24	13,50 USD
2752	24	19,00 USD
2760	25	12,80 USD
2761	25	15,70 USD
2762	25	21,80 USD
2764	25	49,00 USD
2771	24	14,50 USD
2772	24	20,50 USD
2781	25	17,20 USD
2782	25	23,30 USD
2784	25	52,00 USD



2902	26	38,00 USD
2905	26	11,50 USD
2907	26	15,50 USD
2908	26	27,00 USD
2909	26	36,00 USD
2915	26	34,00 USD



2925	27	23,50 USD
2927	27	37,00 USD



3802	29	32,00 USD
------	----	-----------

2912	31	18,00 USD
2912-K	31	38,00 USD
2914	32	27,00 USD
2914-K	32	48,00 USD
2916	33	36,00 USD
2916-K	33	58,00 USD
2918	33	48,00 USD
2932	31	25,00 USD
2932-K	31	46,00 USD
2934	32	38,00 USD
2934-K	32	58,00 USD
2936	33	49,00 USD
2936-K	33	68,00 USD
2938	33	60,00 USD
2938-K	33	82,00 USD
2942	31	38,00 USD
2942-K	31	55,00 USD
2944	32	48,00 USD
2944-K	32	67,00 USD
2946	33	57,00 USD
2946-K	33	77,00 USD
2948	33	71,00 USD
2952	31	46,00 USD
2952-K	31	62,00 USD
2954	32	58,00 USD
2954-K	32	76,00 USD
2956	33	68,00 USD
2956-K	33	85,00 USD
2958	33	80,00 USD
2958-K	33	96,00 USD
2964	32	72,00 USD

2971	34	66,00 USD
2973	34	80,00 USD
2975	34	100,00 USD

2920	35	6,50 USD
2921	35	7,80 USD
2922	35	9,40 USD
2923	35	11,00 USD



1010	42	8,00 USD
1011	42	6,60 USD
1012	42	6,60 USD
1013	42	14,30 USD
1014	42	12,00 USD
1015	42	13,20 USD
1016	42	13,20 USD
1017	42	28,60 USD
1018	42	28,60 USD
1020	41	4,50 USD
1023	41	13,00 USD
1193	42	10,50 USD
8010	41	11,80 USD
8011	41	23,50 USD
8012	41	35,00 USD
8013	41	24,50 USD
8014	41	49,00 USD
8015	41	73,50 USD
8090	41	22,50 USD
8091	41	32,50 USD
8092	41	54,00 USD
8093	41	55,00 USD
8020	37	14,50 USD
8021	37	21,50 USD
8022	37	32,00 USD
8023	37	40,00 USD
8024	37	50,00 USD
8031	38	20,00 USD
8032	38	26,00 USD
8033	38	37,00 USD
8034	38	47,00 USD
8035	38	75,00 USD
8041	39	37,00 USD
8042	39	50,00 USD
8043	39	63,00 USD
8044	39	66,00 USD
8050	39	41,00 USD
8051	39	56,00 USD
8061	40	43,00 USD
8062	40	49,00 USD
8064	40	46,00 USD
8066	40	49,00 USD
8067	40	76,00 USD

Ürün Görseli	Ürün Kodu	Sayfa	Fiyat
--------------	-----------	-------	-------

	1050	47	7,20 USD
	1051	47	9,20 USD
	1052	46	6,20 USD
	1054	46	6,20 USD
	1055	47	6,20 USD
	1056	47	2,00 USD
	8110	46	21,00 USD
	8111	46	42,50 USD
	8112	46	64,00 USD
	8113	46	17,50 USD
	8114	46	34,50 USD
	8115	46	52,00 USD
	8120	44	16,00 USD
	8121	44	18,50 USD
	8122	44	25,00 USD
	8131	44	16,50 USD
	8132	44	28,50 USD
	8133	44	42,00 USD
	8141	45	32,50 USD
	8142	45	43,00 USD
	8150	45	24,50 USD
	8151	45	40,00 USD
	8161	45	54,00 USD
	8190	46	24,50 USD
	8191	46	28,50 USD
	8192	46	41,00 USD

Ürün Görseli	Ürün Kodu	Sayfa	Fiyat
--------------	-----------	-------	-------

	4310	48	2,20 USD
	4311	48	2,00 USD
	4313	49	3,50 USD
	4314	48	1,10 USD
	4316	49	1,90 USD
	4320	50	3,30 USD
	4330	51	3,70 USD
	4334	52	3,15 USD
	4340	53	6,50 USD
	4341	54	22,00 USD
	4342	55	5,20 USD
	1130	52	2,00 USD
	1131	52	0,25 USD
	1135	54	2,50 USD
	1136	54	0,40 USD
	1137	54	0,25 USD
	1138	54	1,40 USD
	1140	51	5,50 USD
	1141	51	0,20 USD
	1142	51	0,20 USD
	1143	51	0,75 USD
	1150	53	5,50 USD
	1151	53	0,20 USD
	1152	53	0,20 USD
	1153	53	0,85 USD
	1155	53	9,00 USD
	1156	55	1,60 USD
	1157	55	2,20 USD
	1158	55	0,20 USD
	1159	55	0,20 USD

	1202	56	8,70 USD
	1204	56	11,50 USD
	1205	56	14,00 USD
	1206	56	16,00 USD
	1207	56	18,50 USD
	1209	56	21,00 USD
	1212	56	12,00 USD
	1214	56	18,50 USD
	1216	56	22,50 USD





3012	57	8,00 USD
3014	57	14,00 USD
3016	57	12,00 USD
3019	57	4,40 USD
3213	57	11,50 USD
3214	57	12,50 USD
3216	57	15,50 USD



5120	58	11,00 USD
5121	58	11,00 USD
5122	58	11,00 USD
5123	58	11,00 USD



3070	59	9,20 USD
3073	59	16,00 USD
3080	59	17,50 USD
3092	59	90,00 USD
3093	59	190,00 USD
9010	59	15,00 USD



5150	61	37,00 USD
5152	61	45,00 USD
5154	61	52,00 USD
5178	60	29,00 USD
5178-K	60	40,00 USD



5170	63	14,00 USD
5171	63	18,50 USD
5171-K	63	26,00 USD
5172	63	18,50 USD
5172-K	63	26,00 USD
5173	63	15,00 USD
5174	63	19,50 USD
5174-K	63	27,00 USD
5175	63	19,50 USD
5175-K	63	27,00 USD



5162	64	18,00 USD
5163	64	24,00 USD
5164	64	25,50 USD
5169	64	47,00 USD



5130	65	11,20 USD
5131	65	11,20 USD
5132	65	11,20 USD
5133	65	11,20 USD
5134	65	14,50 USD



6101	67	10,60 USD
6102	67	10,80 USD
6103	67	10,80 USD
6104	67	20,00 USD
6105	67	9,30 USD
6106	67	11,80 USD



7201	69	11,50 USD
7202	69	15,50 USD
7203	69	21,00 USD
7205	69	26,50 USD
7210	70	45,00 USD
7215	70	85,00 USD
7220	70	102,00 USD
7222	71	35,00 USD
7223	71	40,00 USD
7225	71	48,00 USD
7240	70	260,00 USD

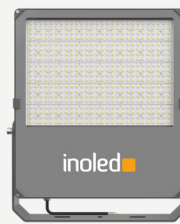

7305	73	140,00 USD
7307	73	150,00 USD
7310	73	160,00 USD
7315	73	190,00 USD
7320	73	250,00 USD
7330	73	420,00 USD
7340	73	530,00 USD
7350	73	750,00 USD
7360	73	880,00 USD



7601	74	50,00 USD
7602	74	70,00 USD
7603	74	100,00 USD



9381	77	60,00 USD
9382	77	90,00 USD
9383	78	115,00 USD
9385	78	170,00 USD



9355	79	53,00 USD
9356	79	70,00 USD
9357	79	105,00 USD
9358	79	125,00 USD
9359	79	145,00 USD
9365	79	250,00 USD
9366	79	310,00 USD



7522	80	165,00 USD
7524	80	185,00 USD
7526	80	240,00 USD



7512	81	67,00 USD
7514	81	87,00 USD
7516	81	110,00 USD



5270	83	160,00 USD
5271	83	190,00 USD
5272	83	210,00 USD
5273	83	240,00 USD
5274	83	300,00 USD
5275	83	330,00 USD
5276	83	400,00 USD



6202	84	23,00 USD
6203	84	23,00 USD
6204	84	23,00 USD
6205	84	23,00 USD



9233	86	9,70 USD
9234	86	9,70 USD
9235	86	9,70 USD
9236	86	9,70 USD
9237	86	11,40 USD
9238	86	11,40 USD
9239	86	11,40 USD
9240	86	11,40 USD
9241	86	12,70 USD
9242	86	12,70 USD
9243	86	12,70 USD
9244	86	12,70 USD



9245	86	10,60 USD
9246	86	10,60 USD
9247	86	10,60 USD
9248	86	10,60 USD
9249	86	12,70 USD
9250	86	12,70 USD
9251	86	12,70 USD
9252	86	12,70 USD
9253	87	14,80 USD
9254	87	14,80 USD
9255	87	14,80 USD
9256	87	14,80 USD
9257	87	16,30 USD
9258	87	16,30 USD
9259	87	16,30 USD
9260	87	16,30 USD
9261	87	23,30 USD
9262	87	23,30 USD
9263	87	23,30 USD
9264	87	23,30 USD
9265	87	27,50 USD
9266	87	27,50 USD
9267	87	27,50 USD
9268	87	27,50 USD
9269	88	17,30 USD
9270	88	17,30 USD
9271	88	17,30 USD
9272	88	17,30 USD
9273	88	23,30 USD
9274	88	23,30 USD
9275	88	23,30 USD
9276	88	23,30 USD
9277	88	21,20 USD
9278	88	21,20 USD
9279	88	21,20 USD
9280	88	21,20 USD
9281	88	26,20 USD
9282	88	26,20 USD

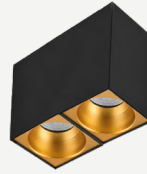

9245	86	10,60 USD
9246	86	10,60 USD
9247	86	10,60 USD
9248	86	10,60 USD
9249	86	12,70 USD
9250	86	12,70 USD
9251	86	12,70 USD
9252	86	12,70 USD
9253	87	14,80 USD
9254	87	14,80 USD
9255	87	14,80 USD
9256	87	14,80 USD
9257	87	16,30 USD
9258	87	16,30 USD
9259	87	16,30 USD
9260	87	16,30 USD
9261	87	23,30 USD
9262	87	23,30 USD
9263	87	23,30 USD
9264	87	23,30 USD
9265	87	27,50 USD
9266	87	27,50 USD
9267	87	27,50 USD
9268	87	27,50 USD
9269	88	17,30 USD
9270	88	17,30 USD
9271	88	17,30 USD
9272	88	17,30 USD
9273	88	23,30 USD
9274	88	23,30 USD
9275	88	23,30 USD
9276	88	23,30 USD
9277	88	21,20 USD
9278	88	21,20 USD
9279	88	21,20 USD
9280	88	21,20 USD
9281	88	26,20 USD
9282	88	26,20 USD



9283	88	26,20 USD
9284	88	26,20 USD
9285	89	12,20 USD
9286	89	12,20 USD
9287	89	12,20 USD
9288	89	12,20 USD
9289	89	17,00 USD
9290	89	17,00 USD
9291	89	17,00 USD
9292	89	17,00 USD



5320	91	40,00 USD
5321	91	55,00 USD
5322	91	63,00 USD
5323	91	44,00 USD
5324	91	60,00 USD
5325	91	68,00 USD
5326	92	50,00 USD
5327	92	69,00 USD
5328	92	77,00 USD



5330	93	153,00 USD
5331	93	205,00 USD
5332	93	279,00 USD
5333	93	363,00 USD
5334	93	449,00 USD
5335	93	588,00 USD



5336	93	711,00 USD
5340	94	141,00 USD
5341	94	218,00 USD
5342	94	359,00 USD
5343	94	514,00 USD
5344	94	703,00 USD

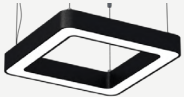

5391	97	200,00 USD
5392	97	266,00 USD
5393	97	332,00 USD
5394	97	399,00 USD
5395	97	189,00 USD
5396	97	251,00 USD
5397	97	314,00 USD



5398	97	377,00 USD
5400	95	150,00 USD
5401	95	299,00 USD
5402	95	399,00 USD
5403	95	498,00 USD



5404	95	142,00 USD
5405	95	283,00 USD
5406	95	377,00 USD
5407	95	471,00 USD
5411	99	180,00 USD
5412	99	268,00 USD
5413	99	358,00 USD

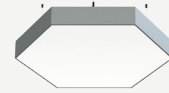

5430	96	157,00 USD
5431	96	262,00 USD
5441	94	165,00 USD
5443	94	218,00 USD
5446	94	292,00 USD



5462	99	262,00 USD
5465	99	433,00 USD
5468	99	724,00 USD
5470	96	174,00 USD
5471	96	252,00 USD
5472	96	381,00 USD
5480	98	257,00 USD
5481	98	326,00 USD
5482	98	397,00 USD
5485	98	185,00 USD
5486	98	230,00 USD
5487	98	267,00 USD



5301	101	24,00 USD
5302	101	32,00 USD
5303	101	38,00 USD
5304	102	45,00 USD
5305	102	59,00 USD
5306	102	72,00 USD
5307	102	90,00 USD



9303	103	25,00 USD
9311	103	31,00 USD
9312	103	38,00 USD
9313	103	60,00 USD
9323	104	34,00 USD
9324	104	56,00 USD
9325	104	18,00 USD
9326	104	26,00 USD
9327	104	30,00 USD



LUMIA

Backlight LED Panel Armatürler
Backlight LED Panel Luminaires

3
YIL
GARANTİ

110 Lm/W | PS DİFÜZÖR | IP40

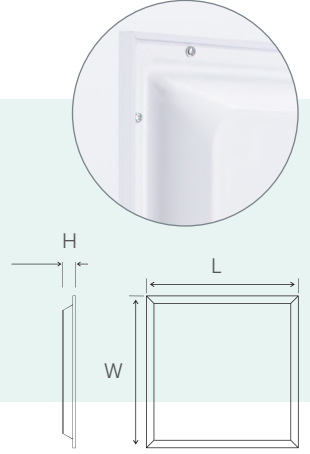

EN
EC
sürücü

Kod Code	Güç Power	Boyutlar W x L x H	Işık Akısı Lumen	Işık Rengi CCT	Adet/Koli Pcs/Carton	Fiyat Price
30 x 30						
4250	15 W	295 X 295 X 31 mm	1650 lm	<input type="radio"/> 01 6500K <input type="radio"/> 02 3000K <input type="radio"/> 03 4000K	20	20,00 USD
30 x 60						
4256	24 W	295 X 595 X 31 mm	2640 lm	<input type="radio"/> 01 6500K <input type="radio"/> 02 3000K <input type="radio"/> 03 4000K	10	29,00 USD
30 x 120						
4258	40 W	295 X 1195 X 31 mm	4400 lm	<input type="radio"/> 01 6500K <input type="radio"/> 02 3000K <input type="radio"/> 03 4000K	10	50,00 USD
60 x 60						
4274	40 W	595 X 595 X 31 mm	4400 lm	<input type="radio"/> 01 6500K <input type="radio"/> 02 3000K <input type="radio"/> 03 4000K	10	29,50 USD



Opsiyonlar	DALI (1-10V) ACİL KİT
------------	--------------------------



PF
≥0,95

110
Lm/W



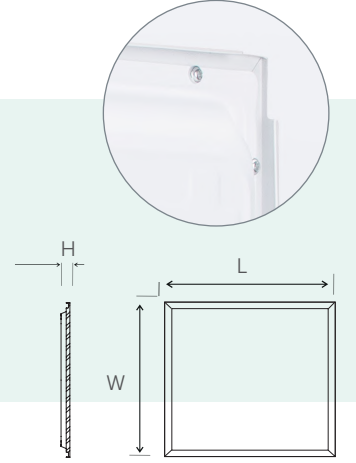

**EN
EC**
sürücü

Kod Code	Güç Power	Boyutlar W x L x H	Işık Akısı Lumen	Işık Rengi CCT	Adet/Koli Pcs/Carton	Fiyat Price
30 x 30						
4260	15 W	300 X 300 X 31 mm	1760 lm	<input type="radio"/> 01 6500K <input type="radio"/> 02 3000K <input type="radio"/> 03 4000K	20	20,00 USD
60 x 60						
4284	40 W	600 X 600 X 31 mm	4400 lm	<input type="radio"/> 01 6500K <input type="radio"/> 02 3000K <input type="radio"/> 03 4000K	10	31,00 USD

Opsiyonlar	DALI (1-10V)
	ACİL KİT



PF
≥0,95

110
Lm/W





**EN
EC**
sürücü

Kod Code	Güç Power	Boyutlar W x L x H	Işık Akısı Lumen	Işık Rengi CCT	Adet/Koli Pcs/Carton	Fiyat Price
30 x 30						
4470	15 W	300 X 300 X 45 mm	1650 lm	01 6500K 02 3000K 03 4000K	16	33,00 USD
30 x 60						
4476	24 W	300 X 600 X 45 mm	2640 lm	01 6500K 02 3000K 03 4000K	8	48,00 USD
30 x 120						
4478	40 W	300 X 1200 X 45 mm	4400 lm	01 6500K 02 3000K 03 4000K	8	71,00 USD
60 x 60						
4474	40 W	600 X 600 X 45 mm	4400 lm	01 6500K 02 3000K 03 4000K	8	51,00 USD



Opsiyonlar	Ürün Kodu	Ürün Adı	Fiyat
	9010	İnoled 2 Saat Acil Durum Kiti	15,00 USD
	9020	1 Saat Acil Durum Aydınlatma Kiti	50,00 USD
	9021	3 Saat Acil Durum Aydınlatma Kiti	59,00 USD
		Dali (1-10V)	

60x60
Alçıpan
Yay Takımı

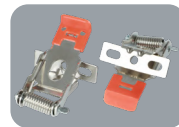

Ürün Kodu	Fiyat
9070	3,00 USD
Takım (4 Adet)	



SUPRA

Backlight LED Panel Armatürler
Backlight LED Panel Luminaires

YIL
5
GARANTİ

TARAK PCB | PMMA DİFÜZÖR | KURUM ŞARTNAMESİNE UYGUN | ENEC SÜRÜCÜ



Kod Code	Güç Power	Boyutlar W x L x H	Işık Akısı Lumen	Işık Rengi CCT	Adet/Koli Pcs/Carton	Fiyat Price
30 x 30						
4670	12 W	295 X 295 X 55 mm	1320 lm	<input checked="" type="radio"/> 01 6500K <input type="radio"/> 02 3000K <input type="radio"/> 03 4000K	14	33,00 USD
30 x 60						
4676	17 W	295 X 595 X 65 mm	1870 lm	<input checked="" type="radio"/> 01 6500K <input type="radio"/> 02 3000K <input type="radio"/> 03 4000K	5	60,00 USD
30 x 120						
4678	36 W	295 X 1195 X 65 mm	4500 lm	<input checked="" type="radio"/> 01 6500K <input type="radio"/> 02 3000K <input type="radio"/> 03 4000K	5	98,00 USD
60 x 60						
4674	36 W	595 X 595 X 55 mm	4500 lm	<input checked="" type="radio"/> 01 6500K <input type="radio"/> 02 3000K <input type="radio"/> 03 4000K	6	65,00 USD

Opsiyonlar

DALI (1-10V)
ACİL KİTPF
≥0,95110
Lm/W

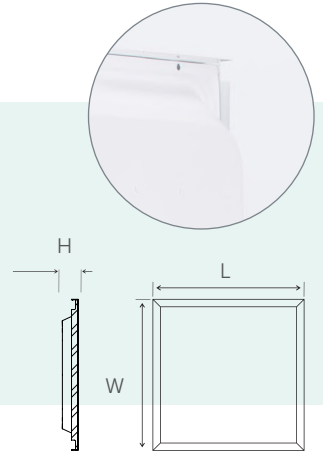

Kod Code	Gc Power	Boyutlar W x L x H	Iık Akısı Lumen	Iık Rengi CCT	Adet/Koli Pcs/Carton	Fiyat Price
30 x 30						
4664	12 W	300 X 300 X 55 mm	1320 lm	<input type="radio"/> 01 6500K <input type="radio"/> 02 3000K <input type="radio"/> 03 4000K	14	36,00 USD
60 x 60						
4684	36 W	600 X 600 X 55 mm	4500 lm	<input type="radio"/> 01 6500K <input type="radio"/> 02 3000K <input type="radio"/> 03 4000K	6	67,00 USD

125Lm/W

Opsiyonlar | DALI (1-10V)
ACİL KİT



PF
≥0,95

110
Lm/W





Kod Code	Güç Power	Boyutlar W x L x H	Işık Akısı Lumen	Işık Rengi CCT	Adet/Koli Pcs/Carton	Fiyat Price
30 x 30						
4880	12 W	310 X 310 X 60 mm	1320 lm	<input type="radio"/> 01 6500K <input type="radio"/> 02 3000K <input type="radio"/> 03 4000K	12	39,00 USD
30 x 60						
4886	17 W	300 X 600 X 60 mm	1870 lm	<input type="radio"/> 01 6500K <input type="radio"/> 02 3000K <input type="radio"/> 03 4000K	5	67,00 USD
30 x 120						
4888	36 W	300 X 1200 X 60 mm	4500 lm	<input type="radio"/> 01 6500K <input type="radio"/> 02 3000K <input type="radio"/> 03 4000K	5	107,00 USD
60 x 60						
4884	36 W	610 X 610 X 60 mm	4500 lm	<input type="radio"/> 01 6500K <input type="radio"/> 02 3000K <input type="radio"/> 03 4000K	5	76,00 USD

125Lm/W

Opsiyonlar

DALI (1-10V)
ACİL KİTPF
≥0,95110
Lm/W

LADIA

LED Downlight Armatür
LED Downlight Luminaire

5
YIL
GARANTİ

105 Lm/W

ALÜMİNYUM GÖVDE

ENEC SÜRÜCÜ

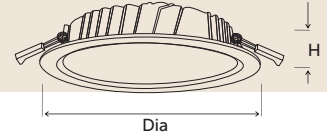
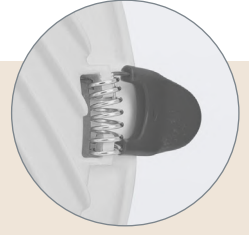

Kod Code	Güç Power	Boyutlar Dia x H	Kesim Çapı Cutting Dia.	Işık Akısı Lumen	Işık Rengi CCT			Adet/Koli Pcs/Carton	Fiyat Price
3702	8 W	Ø 120 x 32 mm	Ø 100 mm	840 lm	01 6500K	02 3000K	03 4000K	30	19,50 USD
3704	12 W	Ø 145 x 32 mm	Ø 125 mm	1260 lm	01 6500K	02 3000K	03 4000K	30	23,00 USD
3706	15 W	Ø 145 x 32 mm	Ø 125 mm	1575 lm	01 6500K	02 3000K	03 4000K	30	25,50 USD
3708	18 W	Ø 180 x 32 mm	Ø 165 mm	1890 lm	01 6500K	02 3000K	03 4000K	20	30,50 USD
3710	24 W	Ø 230 x 32 mm	Ø 200 mm	2520 lm	01 6500K	02 3000K	03 4000K	20	39,00 USD
3712	28 W	Ø 230 x 32 mm	Ø 200 mm	2940 lm	01 6500K	02 3000K	03 4000K	20	42,00 USD

Opsiyonlar | DALI (1-10V)
ACİL KİT



PF
≥0,95

105
Lm/W





Kod Code	Boyutlar Dia x H	Adet/Koli Pcs/Carton	Fiyat Price
120201	Ø 127 x 81 mm	30	13,00 USD
120202	Ø 151 x 81 mm	30	17,00 USD
120203	Ø 184 x 81 mm	20	20,00 USD
120204	Ø 240 x 81 mm	20	23,00 USD

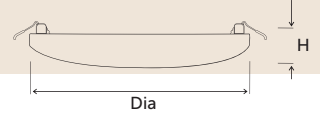
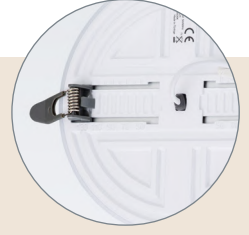
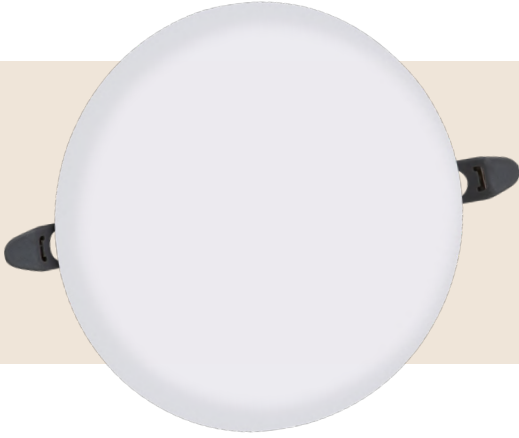

Kod Code	Güç Power	Boyutlar Dia x H	Kesim Çapı Cutting Dia.	Işık Akısı Lumen	Işık Rengi CCT			Adet/Koli Pcs/Carton	Fiyat Price
2502	18 W	Ø 120 x 20 mm	Ø 70 - 110 mm	1800 lm	01 6500K	02 3000K	03 4000K	60	7,50 USD
2504	24 W	Ø 170 x 20 mm	Ø 70 - 155 mm	2400 lm	01 6500K	02 3000K	03 4000K	40	11,00 USD
2506	36 W	Ø 220 x 20 mm	Ø 70 - 200 mm	3600 lm	01 6500K	02 3000K	03 4000K	30	15,00 USD



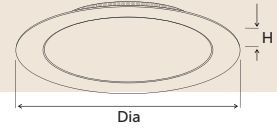
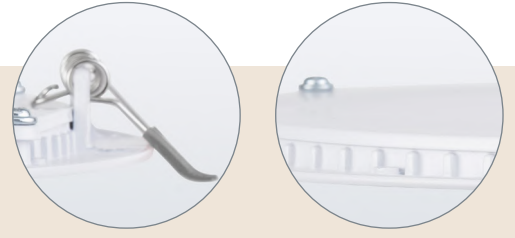
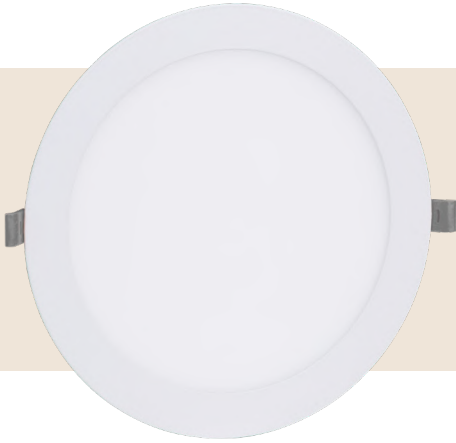

Kod Code	Güç Power	Boyutlar Dia x H	Kesim Çapı Cutting Dia.	Işık Akısı Lumen	Işık Rengi CCT			Adet/Koli Pcs/Carton	Fiyat Price
2703	3 W	Ø 85 x 20 mm	Ø 70 mm	240 lm	01 6500K	02 3000K	03 4000K	100	4,30 USD
2706	6 W	Ø 120 x 20 mm	Ø 105 mm	480 lm	01 6500K	02 3000K	03 4000K	100	5,30 USD
2709	9 W	Ø 145 x 20 mm	Ø 125 mm	720 lm	01 6500K	02 3000K	03 4000K	50	7,50 USD
2712	12 W	Ø 170 x 20 mm	Ø 150 mm	960 lm	01 6500K	02 3000K	03 4000K	50	8,30 USD
2715	15 W	Ø 190 x 20 mm	Ø 170 mm	1200 lm	01 6500K	02 3000K	03 4000K	30	9,60 USD
2718	18 W	Ø 220 x 20 mm	Ø 200 mm	1440 lm	01 6500K	02 3000K	03 4000K	30	10,30 USD
2724	24 W	Ø 300 x 20 mm	Ø 275 mm	1920 lm	01 6500K	02 3000K	03 4000K	20	18,50 USD



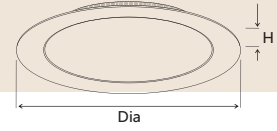
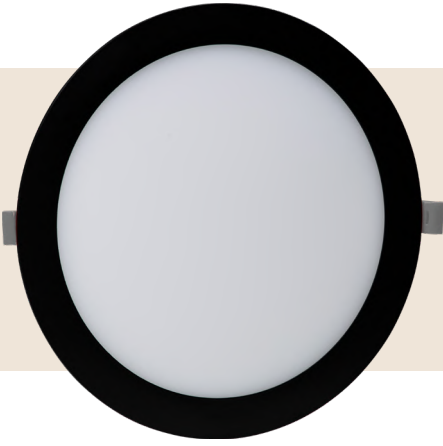

Kod Code	Güç Power	Boyutlar Dia x H	Kesim Çapı Cutting Dia.	Işık Akısı Lumen	Işık Rengi CCT			Adet/Koli Pcs/Carton	Fiyat Price
2803	3 W	Ø 85 x 20 mm	Ø 70 mm	240 lm	01 6500K	02 3000K	03 4000K	100	5,30 USD
2806	6 W	Ø 120 x 20 mm	Ø 105 mm	480 lm	01 6500K	02 3000K	03 4000K	100	6,00 USD
2809	9 W	Ø 145 x 20 mm	Ø 125 mm	720 lm	01 6500K	02 3000K	03 4000K	50	8,30 USD
2812	12 W	Ø 170 x 20 mm	Ø 150 mm	960 lm	01 6500K	02 3000K	03 4000K	50	9,20 USD
2815	15 W	Ø 190 x 20 mm	Ø 170 mm	1200 lm	01 6500K	02 3000K	03 4000K	30	10,70 USD
2818	18 W	Ø 220 x 20 mm	Ø 200 mm	1440 lm	01 6500K	02 3000K	03 4000K	30	11,50 USD
2824	24 W	Ø 300 x 20 mm	Ø 275 mm	1920 lm	01 6500K	02 3000K	03 4000K	20	20,00 USD



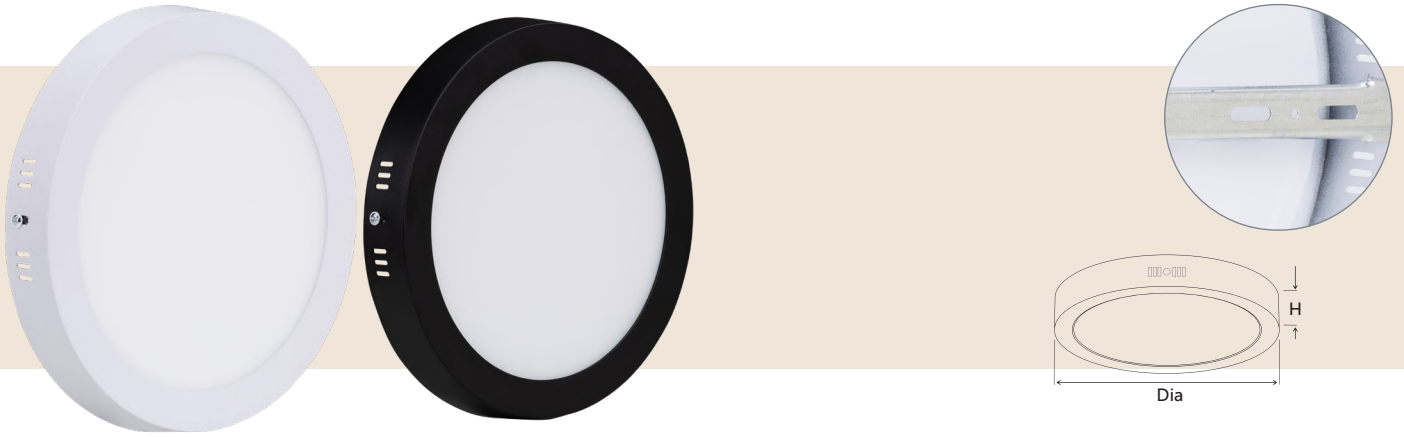

Kod Code	Güç Power	Gövde Housing	Boyutlar Dia x H	Işık Akısı Lumen	Işık Rengi CCT			Adet/Koli Pcs/Carton	Fiyat Price
2750	12 W	Beyaz White	Ø 170 x 32 mm	960 lm	01 6500K	02 3000K	03 4000K	20	11,20 USD
2751	18 W	Beyaz White	Ø 225 x 32 mm	1440 lm	01 6500K	02 3000K	03 4000K	20	13,50 USD
2752	24 W	Beyaz White	Ø 300 x 32 mm	1920 lm	01 6500K	02 3000K	03 4000K	20	19,00 USD
2771	18 W	Siyah Black	Ø 225 x 32 mm	1440 lm	01 6500K	02 3000K	03 4000K	20	14,50 USD
2772	24 W	Siyah Black	Ø 300 x 32 mm	1920 lm	01 6500K	02 3000K	03 4000K	20	20,50 USD



Sıva Üstü Kare LED Panel Armatür
Surface Mounted Square LED Panel Luminaire

VOLGA

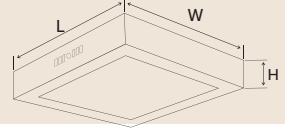

Kod Code	Güç Power	Gövde Housing	Boyutlar W x L x H	Işık Akısı Lumen	Işık Rengi CCT			Adet/Koli Pcs/Carton	Fiyat Price
2760	12 W	Beyaz White	170 x 170 x 32 mm	960 lm	01 6500K	02 3000K	03 4000K	20	12,80 USD
2761	18 W	Beyaz White	225 x 225 x 32 mm	1440 lm	01 6500K	02 3000K	03 4000K	20	15,70 USD
2762	24 W	Beyaz White	300 x 300 x 32 mm	1920 lm	01 6500K	02 3000K	03 4000K	20	21,80 USD
2781	18 W	Siyah Black	225 x 225 x 32 mm	1440 lm	01 6500K	02 3000K	03 4000K	20	17,20 USD
2782	24 W	Siyah Black	300 x 300 x 32 mm	1920 lm	01 6500K	02 3000K	03 4000K	20	23,30 USD

Sıva Üstü Kare Sensörlü LED Panel Armatür
Surface Mounted Square Sensor LED Panel Luminaire

VOLGA

2764	24 W	Beyaz White	300 x 300 x 32 mm	1920 lm	01 6500K	02 3000K	03 4000K	20	49,00 USD
2784	24 W	Siyah Black	300 x 300 x 32 mm	1920 lm	01 6500K	02 3000K	03 4000K	20	52,00 USD

PIR Sensör)))

PIR Sensör)))



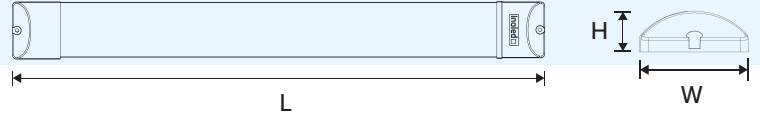

Kod Code	Güç Power	Boyutlar W x L x H	Işık Akısı Lumen	Işık Rengi CCT	Adet/Koli Pcs/Carton	Fiyat Price
2905	18 W	68 x 600 x 26 mm	1890 lm	01 6500K 02 3000K 03 4000K	30	11,50 USD
2907	36 W	68 x 1200 x 26 mm	3780 lm	01 6500K 02 3000K 03 4000K	30	15,50 USD
2908	54 W	68 x 1200 x 26 mm	5670 lm	01 6500K 02 3000K 03 4000K	30	27,00 USD
2909	120Lm/W 72 W	68 x 1200 x 26 mm	8640 lm	01 6500K 02 3000K 03 4000K	30	36,00 USD
2915	36 W	68 x 1200 x 26 mm	3780 lm	01 6500K	30	34,00 USD
2902	5 YIL GARANTİ 36 W	68 x 1200 x 26 mm	3780 lm	01 6500K 02 3000K 03 4000K	30	38,00 USD

PIR Sensör)))

EN
EC
sürücü





Kod Code	Güç Power	Boyutlar W x L x H	Işık Akısı Lumen	Işık Rengi CCT	Adet/Koli Pcs/Carton	Fiyat Price						
2925	24 W	70 x 600 x 38 mm	2640 lm	<table border="1"><tr><td>01</td><td>02</td><td>03</td></tr><tr><td>6500K</td><td>3000K</td><td>4000K</td></tr></table>	01	02	03	6500K	3000K	4000K	25	23,50 USD
01	02	03										
6500K	3000K	4000K										
2927	54 W	70 x 1200 x 38 mm	5940 lm	<table border="1"><tr><td>01</td><td>02</td><td>03</td></tr><tr><td>6500K</td><td>3000K</td><td>4000K</td></tr></table>	01	02	03	6500K	3000K	4000K	25	37,00 USD
01	02	03										
6500K	3000K	4000K										

Uç Uca eklenebilirlik;
- 24W ürünlerde 16 adet
- 54W ürünlerde 8 adet



GLORA

Kristal LED Bant Armatür
Crystal LED Batten Luminaire



FR4 PCB

ALÜMİNYUM GÖVDE

PF>0,9

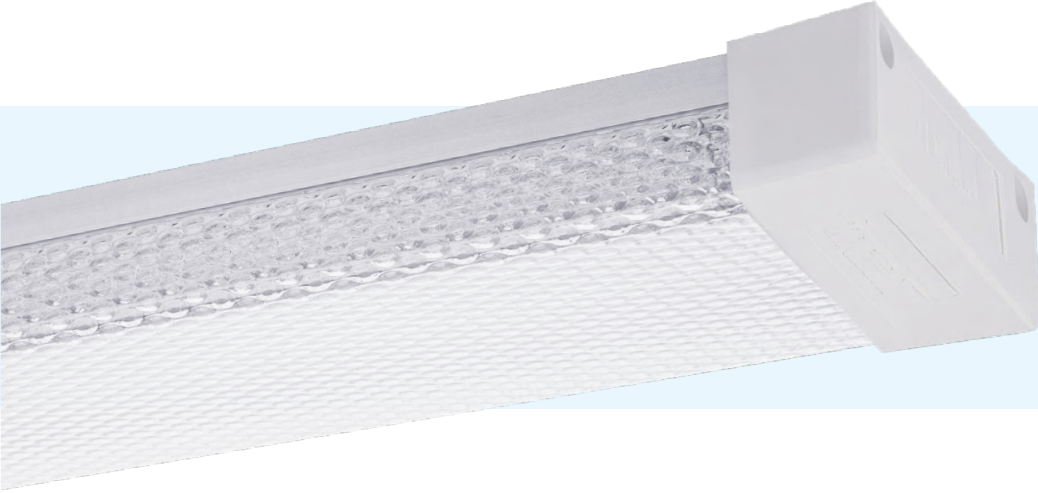

Kod Code	Güç Power	Boyutlar W x L x H	Işık Akısı Lumen	Işık Rengi CCT	Adet/Koli Pcs/Carton	Fiyat Price						
3802	80 W	90 x 1200 x 35 mm	8400 lm	<table><tr><td>01</td><td>02</td><td>03</td></tr><tr><td>6500K</td><td>3000K</td><td>4000K</td></tr></table>	01	02	03	6500K	3000K	4000K	30	32,00 USD
01	02	03										
6500K	3000K	4000K										

- Difüzör düşmesine karşı güvenli tasarım
- FR4 PCB, stabil ve uzun ömürlü ışık performansı
- Yüksek güç faktörü, verimli enerji kullanımı
- Alüminyum gövde, yüksek mekanik dayanım



ASPERA

LED Etanj Armatür
LED Waterproof Luminaire

3
YIL
GARANTİ

120 Lm/W

POLİKARBON GÖVDE

IP65

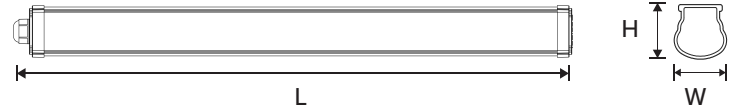
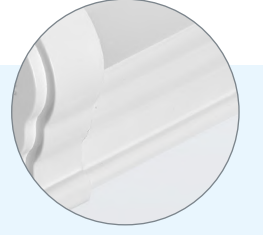
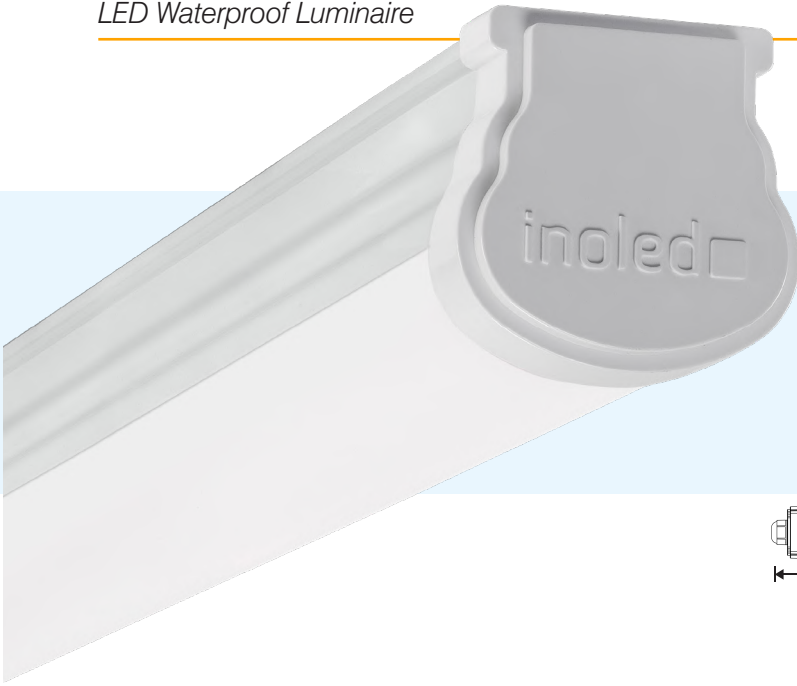

Güç Power	Kod Code	Opsiyonlar Options	Işık Akısı Lumen	Işık Rengi CCT	Adet/Koli Pcs/Carton	Fiyat Price
20 W	2912		2400 lm		30	18,00 USD
	2912-K	Acil Kit	2400 lm		30	38,00 USD
	2932	EN EC sürücü	2400 lm		30	25,00 USD
	2932-K	Acil Kit EN EC sürücü	2400 lm	01 6500K 02 3000K 03 4000K	30	46,00 USD
	2942	Radar Sensör)))	2400 lm		30	38,00 USD
	2942-K	Radar Sensör))) Acil Kit	2400 lm		30	55,00 USD
	2952	Radar Sensör))) EN EC sürücü	2400 lm		30	46,00 USD
	2952-K	Radar Sensör))) Acil Kit EN EC sürücü	2400 lm		30	62,00 USD

Boyutlar : 52 x 600 x 52 mm (W x L x H)

Acil aydınlatma süresi 2 saattir.

3
YIL
GARANTİ

ENEC sürücülü ürünlerde geçerlidir.

Opsiyonlar | DALI (1-10V)



PF
≥0,9

120
Lm/W





LED Etanj Armatür
LED Waterproof Luminaire

ASPERA

Güç Power	Kod Code	Opsiyonlar Options	Işık Akısı Lumen	Işık Rengi CCT	Adet/Koli Pcs/Carton	Fiyat Price
40 W	2914		4800 lm		30	27,00 USD
	2914-K		4800 lm		30	48,00 USD
	2934		4800 lm		30	38,00 USD
	2934-K		4800 lm		30	58,00 USD
	2944		4800 lm		30	48,00 USD
	2944-K		4800 lm		30	67,00 USD
	2954		4800 lm		30	58,00 USD
	2954-K		4800 lm		30	76,00 USD
	2964		4800 lm		30	72,00 USD

Boyutlar : 52 x 1200 x 52 mm (W x L x H)

Acil aydınlatma süresi 2 saattir.

3
YIL
GARANTİ

ENEC sürücülü ürünlerde geçerlidir.

Opsiyonlar | DALI (1-10V)

AC
220 V

PF
≥0,9

120
Lm/W

120°

30.000
h.















IP65

IK 08

RoHS
COMPLIANT

CE

inoled

Güç Power	Kod Code	Opsiyonlar Options	Işık Akısı Lumen	Işık Rengi CCT	Adet/Koli Pcs/Carton	Fiyat Price
60 W	2916		7200 lm		30	36,00 USD
	2916-K		7200 lm		30	58,00 USD
	2936	 	7200 lm		30	49,00 USD
	2936-K	 	7200 lm		30	68,00 USD
	2946		7200 lm		30	57,00 USD
	2946-K	 	7200 lm		30	77,00 USD
	2956	 	7200 lm		30	68,00 USD
	2956-K	  	7200 lm		30	85,00 USD

Boyutlar : 52 x 1200 x 52 mm (W x L x H)

Acil aydınlatma süresi 2 saattir.

Güç Power	Kod Code	Opsiyonlar Options	Işık Akısı Lumen	Işık Rengi CCT	Adet/Koli Pcs/Carton	Fiyat Price
80 W	2918		9600 lm		20	48,00 USD
	2938		9600 lm		20	60,00 USD
	2938-K	 	9600 lm		20	82,00 USD
	2948		9600 lm		20	71,00 USD
	2958	 	9600 lm		20	80,00 USD
	2958-K	  	9600 lm		20	96,00 USD

Boyutlar : 52 x 1500 x 52 mm (W x L x H)

Acil aydınlatma süresi 2 saattir.

3
YIL
GARANTİ

ENEC sürücülü ürünlerde geçerlidir.

Opsiyonlar	DALI (1-10V)
------------	--------------





Ex-Proof Etanj Armatürler
Ex-Proof Waterproof Luminaires

ASPERA LED EX-PROOF



YENİ
ÜRÜN

Zone2 II 3G Ex nR IIC T6 Gc
Zone22 II 3D Ex tc IIIC T80°C Dc



Kod Code	Güç Power	Boyutlar W x L x H	Işık Akısı Lumen	Işık Rengi CCT	Adet / Koli Pcs / Carton	Fiyat Price
2971	18 W	52 x 600 x 52 mm	2160 lm	01 6500K	30	66,00 USD
2973	36 W	52 x 1200 x 52 mm	4320 lm	01 6500K	30	80,00 USD
2975	54 W	52 x 1500 x 52 mm	6480 lm	01 6500K	30	100,00 USD

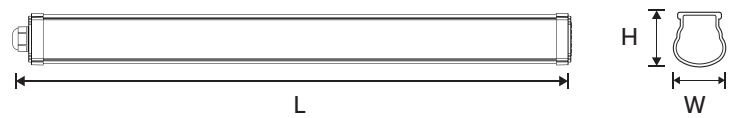

inoled



T5 LED Bant Armatür
T5 LED Batten Luminaire



Kod Code	Güç Power	Boyutlar W x L x H	Işık Akısı Lumen	Işık Rengi CCT	Adet / Koli Pcs / Carton	Fiyat Price
2920	4 W	22 x 291 x 36 mm	400 lm	01 6500K 02 3000K	50	6,50 USD
2921	8 W	21 x 591 x 36 mm	800 lm	01 6500K 02 3000K	50	7,80 USD
2922	12 W	21 x 859 x 36 mm	1200 lm	01 6500K 02 3000K	50	9,40 USD
2923	16 W	21 x 1172 x 36 mm	1600 lm	01 6500K 02 3000K	50	11,00 USD

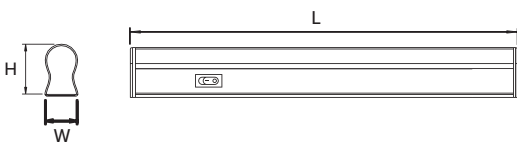

MAGLINE SLIM

Magnet Armatürler
Magnet Luminaires

3
YIL
GARANTİ

YENİ
ÜRÜN



Magnet Armatürler
Magnet Luminaires

MAGLINE SLIM



Kod Code	Güç Power	Işık Akısı Lumen	Işık Rengi CCT	Adet/Koli Pcs/Carton	Fiyat Price
8020	6 W	400 lm	02 3000K	100	14,50 USD
			03 4000K		
		340 lm	3C 3 CCT		

Boyutlar : 26 x 122 x 24 mm (W x L x H)

8021	12 W	900 lm	02 3000K	50	21,50 USD
			03 4000K		
		750 lm	3C 3 CCT		

Boyutlar : 26 x 230 x 24 mm (W x L x H)

8022	18 W	1350 lm	02 3000K	50	32,00 USD
			03 4000K		
		1100 lm	3C 3 CCT		

Boyutlar : 26 x 338 x 24 mm (W x L x H)

8023	24 W	1800 lm	02 3000K	50	40,00 USD
			03 4000K		
		1500 lm	3C 3 CCT		

Boyutlar : 26 x 445 x 24 mm (W x L x H)

8024	30 W	2250 lm	02 3000K	40	50,00 USD
			03 4000K		
		1800 lm	3C 3 CCT		

Boyutlar : 26 x 555 x 24 mm (W x L x H)

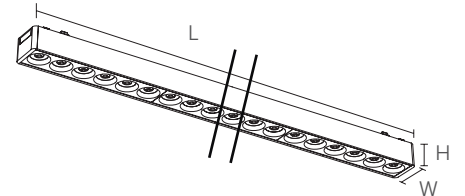

OSRAM LED

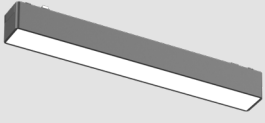

Kod Code	Güç Power	Işık Akısı Lumen	Işık Rengi CCT	Adet/Koli Pcs/Carton	Fiyat Price
8031	12 W	400 lm	02 3000K	50	20,00 USD
			03 4000K		
		340 lm	3C 3 CCT		

Boyutlar : 26 x 230 x 24 mm (W x L x H)

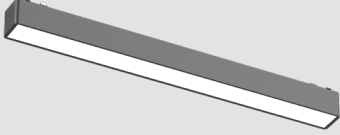

Kod Code	Güç Power	Işık Akısı Lumen	Işık Rengi CCT	Adet/Koli Pcs/Carton	Fiyat Price
8032	18 W	900 lm	02 3000K	50	26,00 USD
			03 4000K		
		750 lm	3C 3 CCT		

Boyutlar : 26 x 338 x 24 mm (W x L x H)

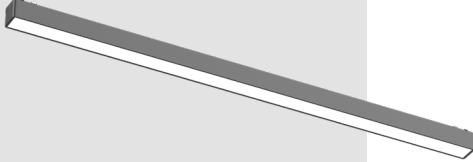

Kod Code	Güç Power	Işık Akısı Lumen	Işık Rengi CCT	Adet/Koli Pcs/Carton	Fiyat Price
8033	24 W	1350 lm	02 3000K	50	37,00 USD
			03 4000K		
		1100 lm	3C 3 CCT		

Boyutlar : 26 x 615 x 24 mm (W x L x H)

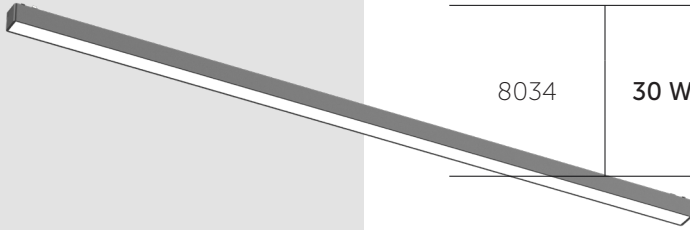

Kod Code	Güç Power	Işık Akısı Lumen	Işık Rengi CCT	Adet/Koli Pcs/Carton	Fiyat Price
8034	30 W	1800 lm	02 3000K	40	47,00 USD
			03 4000K		
		1500 lm	3C 3 CCT		

Boyutlar : 26 x 915 x 24 mm (W x L x H)

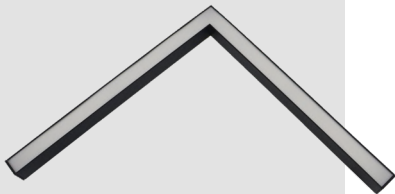
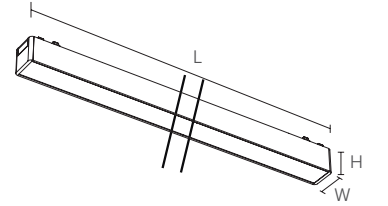

Kod Code	Güç Power	Işık Akısı Lumen	Işık Rengi CCT	Adet/Koli Pcs/Carton	Fiyat Price
8035	20W	1500 lm	02 3000K	20	75,00 USD
			03 4000K		
		1275 lm	3C 3 CCT		

Boyutlar : 26 x 320 x 24 mm (W x L x H)

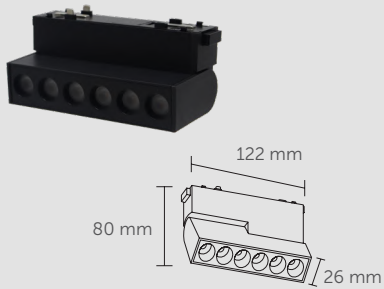
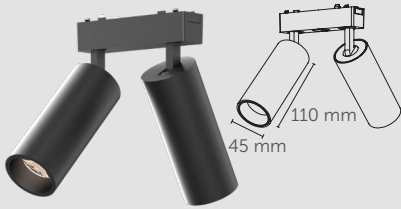
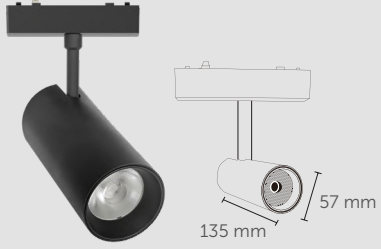

Kod Code	Güç Power	Işık Akısı Lumen	Işık Rengi CCT	Adet/Koli Pcs/Carton	Fiyat Price
8041	10 W	400 lm	02 3000K	20	37,00 USD
			03 4000K		
		340 lm	3C 3 CCT		

8042	20 W	900 lm	02 3000K	20	50,00 USD
			03 4000K		
		750 lm	3C 3 CCT		

8043	30 W	1350 lm	02 3000K	20	63,00 USD
			03 4000K		
		1100 lm	3C 3 CCT		

8044	10 + 10W	1800 lm	02 3000K	20	66,00 USD
			03 4000K		
		1500 lm	3C 3 CCT		

8050	6 W	1350 lm	02 3000K	40	41,00 USD
			03 4000K		
		1100 lm	3C 3 CCT		

8051	12 W	1800 lm	02 3000K	40	56,00 USD
			03 4000K		
		1500 lm	3C 3 CCT		

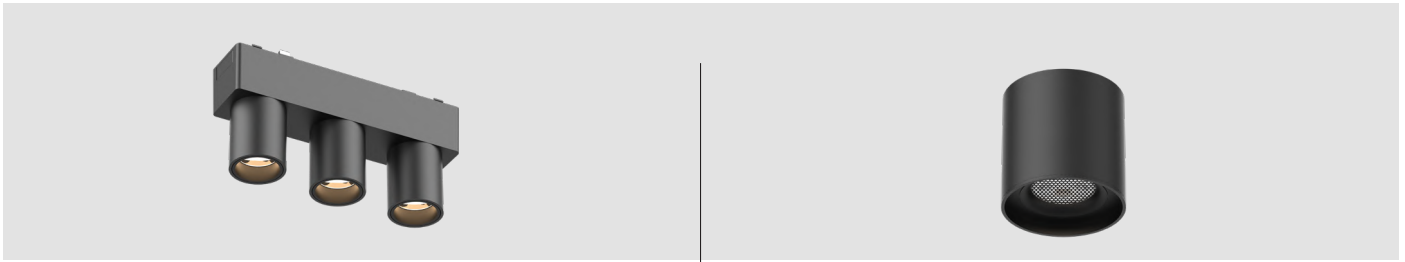

Kod Code	Güç Power	Işık Akısı Lumen	Adet/Koli Pcs/Carton	Kod Code	Güç Power	Işık Akısı Lumen	Adet/Koli Pcs/Carton
8061	6 W	400 Lm	40	8062	6 W	400 Lm	20

Işık Rengi CCT		Işık Rengi CCT	
	3 CCT		3 CCT
43,00 USD		49,00 USD	



Kod Code	Güç Power	Işık Akısı Lumen	Kod Code	Güç Power	Işık Akısı Lumen	Kod Code	Güç Power	Işık Akısı Lumen
8064	12 W	820 Lm	8066	6 W	400 Lm	8067	6 W	400 Lm

Adet/Koli Pcs/Carton		Işık Rengi CCT		Adet/Koli Pcs/Carton		Işık Rengi CCT		Adet/Koli Pcs/Carton		Işık Rengi CCT	
20		3 CCT	46,00 USD	8		3 CCT	49,00 USD	10		3 CCT	76,00 USD

Magnet Ray Magnet Track

MAGLINE SLIM



Kod Code	Boyutlar W x L x H	Adet/Koli Pcs/Carton	Fiyat Price
8010	26 x 1000 x 6.5 mm	40	11,80 USD
8011	26 x 2000 x 6.5 mm	40	23,50 USD
8012	26 x 3000 x 6.5 mm	30	35,00 USD

Kod Code	Boyutlar W x L x H	Adet/Koli Pcs/Carton	Fiyat Price
8013	67.3 x 1000 x 30.7 mm	10	24,50 USD
8014	67.3 x 2000 x 30.7 mm	10	49,00 USD
8015	67.3 x 3000 x 30.7 mm	10	73,50 USD

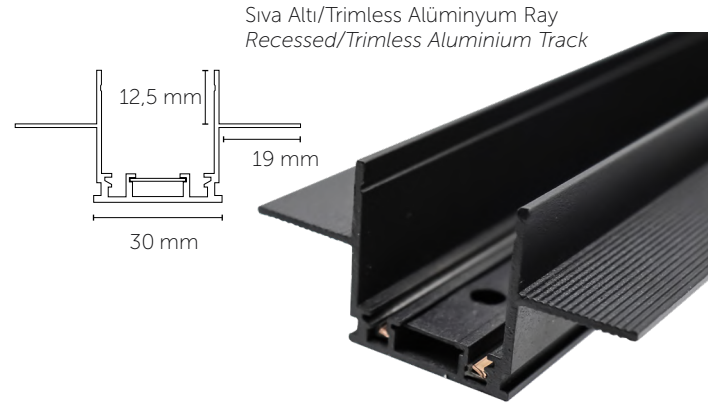

Magnet Aksesuar Magnet Accessories

Sürücü Saklama
Kutusu
Cover Box

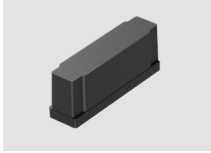

Kod / Code	1020
Koli / Carton	100
Fiyat / Price	4,50 USD

Düz Besleme
Modülü
Straight Module

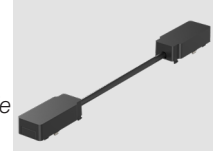

Kod / Code	1023
Koli / Carton	100
Fiyat / Price	13,00 USD

Magnet Sürücü Magnet Driver



Kod Code	Çıkış Output	Güç Power	Boyutlar W x L x H	Adet/Koli Pcs/Carton	Fiyat Price
8090	DC48V	50 W	70 x 600 x 38 mm	50	22,50 USD
8091	DC48V	100 W	26 x 210 x 24 mm	50	32,50 USD
8092	DC48V	200 W	26 x 310 x 24 mm	50	54,00 USD
8093	DC48V	200 W*	26 x 345 x 24 mm	40	55,00 USD

*3C SMART

Kumanda - 3C Smart
Remote Control - 3C SMART



Kod Code	Adet/Koli Pcs/Carton	Fiyat Price
1193	50	10,50 USD

Sıva Üstü Birleştirme Aparatı - 90° Tavan/Duvar
Surface - 90° Vertical Jointer

Kod Code	Adet/Koli Pcs/Carton
-------------	-------------------------

1010 100

Boyutlar : 25 x 25 x 26 mm



8,00 USD

Sıva Üstü Birleştirme Aparatı - Dört Yönlü
Surface - + Joint /Cross Joint

Kod Code	Adet/Koli Pcs/Carton
-------------	-------------------------

1014 100

Boyutlar : 59 x 59 x 6 mm



12,00 USD

Sıva Üstü Birleştirme Aparatı - Düz
Surface - Straight Jointer

Kod Code	Adet/Koli Pcs/Carton
-------------	-------------------------

1011 100

Boyutlar : 59 x 26 x 6 mm



6,60 USD

Sıva Altı Birleştirme Aparatı - 90° Tavan/Duvar
Recessed - 90° Vertical Jointer

Kod Code	Adet/Koli Pcs/Carton
-------------	-------------------------

1015 50

Boyutlar : 100 x 100 mm



13,20 USD

Surface - 90° Horizontal Jointer
Sıva Üstü Birleştirme Aparatı - 90° Tavan/Tavan

Kod Code	Adet/Koli Pcs/Carton
-------------	-------------------------

1012 100

Boyutlar : 43 x 43 x 6 mm



6,60 USD

Sıva Altı Birleştirme Aparatı - 90° Tavan/Tavan
Recessed - 90° Horizontal Jointer

Kod Code	Adet/Koli Pcs/Carton
-------------	-------------------------

1016 50

Boyutlar : 100 x 100 mm



13,20 USD

Sıva Üstü Birleştirme Aparatı - T Bağlantı
Surface - T Jointer

Kod Code	Adet/Koli Pcs/Carton
-------------	-------------------------

1013 100

Boyutlar : 59 x 43 x 6 mm



14,30 USD

Sıva Altı Birleştirme Aparatı - T Bağlantı
Recessed - T Jointer

Kod Code	Adet/Koli Pcs/Carton
-------------	-------------------------

1017 50

Boyutlar : 200 x 100 mm



28,60 USD

Sıva Altı Birleştirme Aparatı - Dört Yönlü
Recessed - + Joint /cross joint



Kod Code	Adet/Koli Pcs/Carton
-------------	-------------------------

1018 50

Boyutlar : 200 x 200 mm

28,60 USD

MAGLINE CORE

Magnet Armatürler
Magnet Luminaires

YIL-
3
GARANTİ

YENİ
ÜRÜN





OSRAM LED

Kod Code	Güç Power	Boyutlar W x L x H	Işık Akısı Lumen	Işık Rengi CCT	Adet/Koli Pcs/Carton	Fiyat Price
8120	6 W	22 x 110 x 43 mm	400 lm	02 3000K 03 4000K	60	16,00 USD
8121	12 W	22 x 220 x 43 mm	900 lm	02 3000K 03 4000K	60	18,50 USD
8122	18 W	22 x 330 x 43 mm	1350 lm	02 3000K 03 4000K	50	25,00 USD



OSRAM LED

Kod Code	Güç Power	Boyutlar W x L x H	Işık Akısı Lumen	Işık Rengi CCT	Adet/Koli Pcs/Carton	Fiyat Price
8131	12 W	22 x 300 x 43 mm	900 lm	02 3000K 03 4000K	50	16,50 USD
8132	24 W	22 x 600 x 43 mm	1800 lm	02 3000K 03 4000K	50	28,50 USD
8133	30 W	22 x 900 x 43 mm	2250 lm	02 3000K 03 4000K	50	42,00 USD



Kod Code	Güç Power	Işık Akısı Lumen	Işık Rengi CCT	Adet/Koli Pcs/Carton	Fiyat Price
8141	12 W	400 lm	02 3000K	40	32,50 USD
			03 4000K		

8142	20 W	900 lm	02 3000K	40	43,00 USD
			03 4000K		

8150	6 W	1800 lm	02 3000K	50	24,50 USD
			03 4000K		

8151	12 W	1350 lm	03 4000K	50	40,00 USD
		1100 lm	3C 3 CCT		

8161	12 W	1350 lm	02 3000K	20	54,00 USD
			03 4000K		

Magnet Ray Magnet Track

MAGLINE CORE

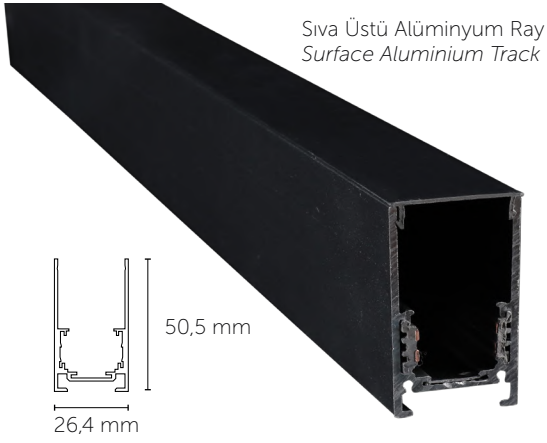

Siva Üstü Alüminyum Ray
Surface Aluminium Track

Kod Code	Boyutlar W x L x H	Adet/Koli Pcs/Carton	Fiyat Price
8110	26,4 x 1000 x 50,5 mm	10	21,00 USD
8111	26,4 x 2000 x 50,5 mm	10	42,50 USD
8112	26,4 x 3000 x 50,5 mm	10	64,00 USD

Kod Code	Boyutlar W x L x H	Adet/Koli Pcs/Carton	Fiyat Price
8113	56 x 1000 x 45 mm	10	17,50 USD
8114	56 x 2000 x 45 mm	10	34,50 USD
8115	56 x 3000 x 45 mm	10	52,00 USD

Siva Altı/Trimless Alüminyum Ray
Recessed/Trimless Aluminium Track

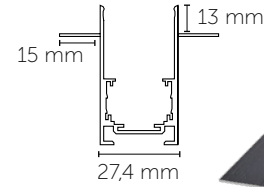

Magnet Aksesuar Magnet Accessories

Besleme Modülü
4 Kablolü
Input Module
4 Wires



Kod / Code	1052
Koli / Carton	100
Fiyat / Price	6,20 USD

Besleme Modülü
2 Kablolü
Corner Module
2 Wires



Kod / Code	1054
Koli / Carton	100
Fiyat / Price	6,20 USD

Magnet Sürücü Magnet Driver



Kod Code	Çıkış Output	Güç Power	Boyutlar W x L x H	Adet/Koli Pcs/Carton	Fiyat Price
8190	DC48V	50 W	22 x 185 x 43 mm	50	24,50 USD
8191	DC48V	100 W	22 x 225 x 43 mm	50	28,50 USD
8192	DC48V	200 W	22 x 305 x 43 mm	40	41,00 USD

Sıva Üstü Birleştirme Aparatı - 90° Tavan/Tavan
Surface - 90° Horizontal Jointer

Kod Code	Adet/Koli Pcs/Carton
1050	50

Boyutlar : 100 x 100 mm



7,20 USD

Sıva Üstü Çelik Askı Takımı - 150cm
Surface - Hanging Stain Steel

Kod Code	Adet/Koli Pcs/Carton
1055	50

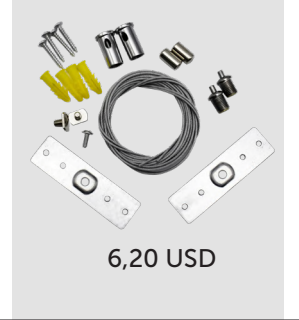

6,20 USD

Sıva Altı Birleştirme Aparatı - 90° Tavan/Tavan
Recessed - 90° Horizontal Jointer

Kod Code	Adet/Koli Pcs/Carton
1051	50

Boyutlar : 100 x 100 mm



9,20 USD

Ray Konnektör - Düz
Straight Connector

Kod Code	Adet/Koli Pcs/Carton
1056	200

Boyutlar : 401 x 236 mm



2,00 USD



LED Şerit
LED Strip

DC 12V - SMD 2835 120 LED / İç Ortam



3
YIL
GARANTİ

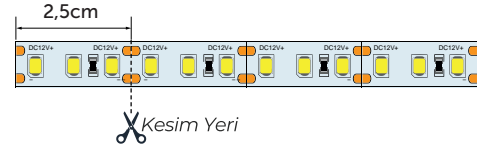

YENİ
ÜRÜN



Kod Code	Işık Rengi CCT	Miktar/Koli Quantity/Carton	Fiyat Price
4311	01 6500K	500 mt	2,00 USD
	02 3000K		
	07 4000K		2,20 USD



Kod Code	Işık Rengi CCT	Miktar/Koli Quantity/Carton	Fiyat Price
4314	01 6500K	500 mt	1,10 USD
	02 3000K		
	03 Kırmızı		
	04 Yeşil		1,20 USD
	05 Mavi		
	07 4000K		
	08 Amber		
10 Pembe	1,10 USD		
4310	06 RGB*	500 mt	2,20 USD

*SMD 5050

inoled

LED Şerit
LED Strip

DC 12V - SMD 2835 240 LED / İç Ortam



3
YIL
GARANTİ

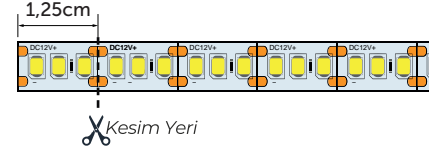

YENİ
ÜRÜN



Kod Code	Işık Rengi CCT	Miktar/Koli Quantity/Carton	Fiyat Price
4313	01 6500K	500 mt	3,50 USD
	02 3000K		
	07 4000K		3,70 USD



Kod Code	Işık Rengi CCT	Miktar/Koli Quantity/Carton	Fiyat Price
4316	01 6500K	500 mt	1,90 USD
	02 3000K		
	07 4000K		
	08 Amber		2,10 USD

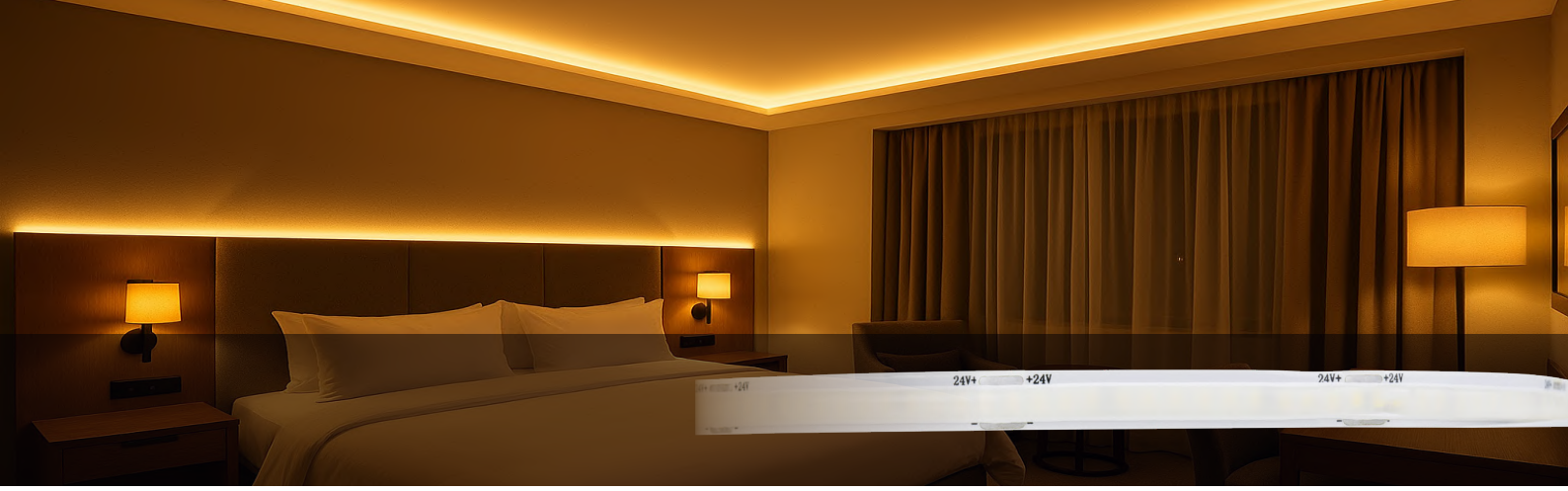

LED Şerit LED Strip

DC 24V - SCOB 280 LED / İç Ortam

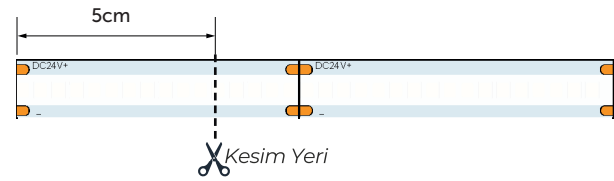

280 LED/m	9 W/m	DC 24 V	990 Lm/m	CRI ≥80	50.000 h.	IP20	III	House
--------------	----------	------------	-------------	------------	--------------	------	-----	-------

Kod Code	Işık Rengi CCT	Miktar/Koli Quantity/Cartron	Fiyat Price
4320	01 6500K	500 mt	3,30 USD
	02 3000K		
	07 4000K		3,50 USD
	08 Amber		

SCOB Yeni Nesil LED Teknolojisi

- Gelişmiş üretim yapısı ile tasarlanmış yeni nesil LED şerit teknolojisi
- Yeni nesil silikon kaplama yapısı ile uzun süre stabil performans
- Homojen ışık görünümü ile kesintisiz lineer ışık hattı
- Modern ve sade ışık görünümü
- Esnek yapı, dar ve kavisli alanlara uyumlu

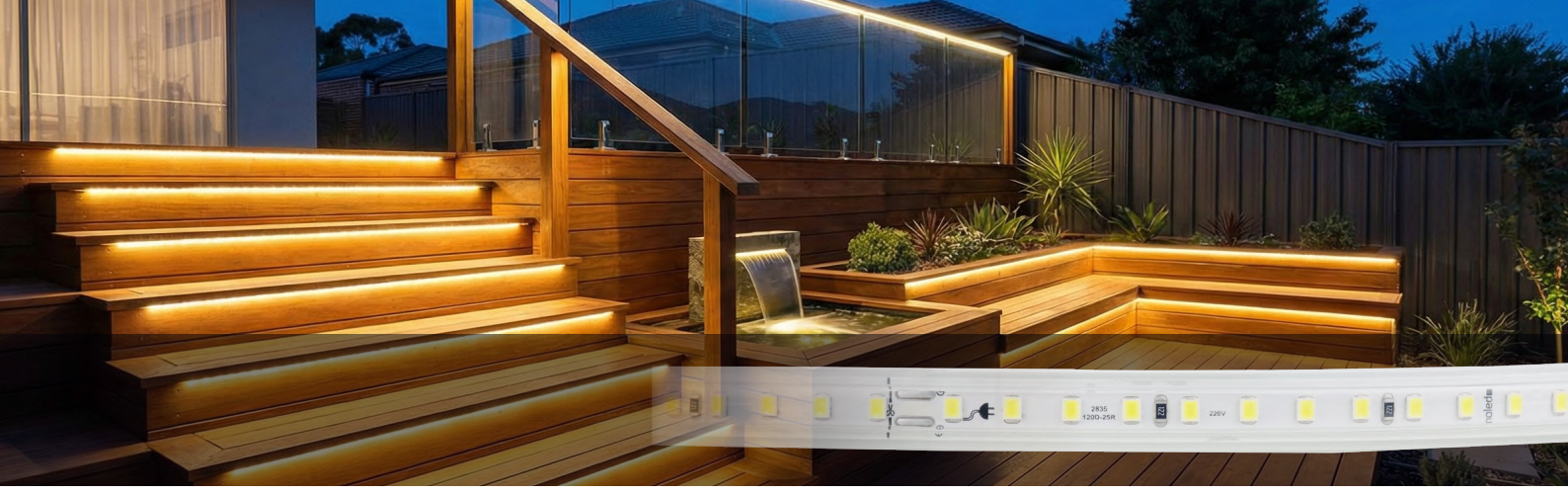

LED Şerit
LED Strip

AC 220V - SMD 2835 120 LED / Dış Ortam

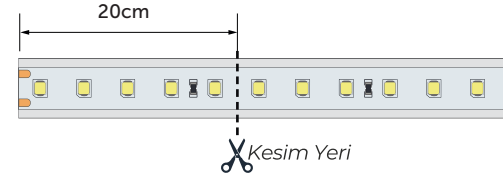
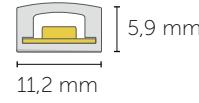

Kod Code	Işık Rengi CCT	Miktar/Koli Quantity/Cartron	Fiyat Price
4330	01 6500K	100 mt	3,70 USD
	02 3000K		
	03 Kırmızı		
	04 Yeşil		
	05 Mavi		
	07 4000K		
	08 Amber		

Bir koli 4 adet bağlantı fişi +10 adet uç kapak içerir.

Bağlantı Kablosu
Power Cable

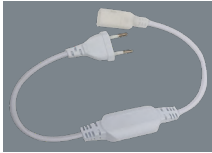

Kod / Code	1140
Koli / Carton	1
Fiyat / Price	5,50 USD

Sabitleme Aparatı
Fixing Clip



Kod / Code	1142
Koli / Carton	10
Fiyat / Price	0,20 USD

Uç Kapak
End Cap



Kod / Code	1141
Koli / Carton	10
Fiyat / Price	0,20 USD

Ara Bağlantı Aparatı
Interconnection Pin



Kod / Code	1143
Koli / Carton	10
Fiyat / Price	0,75 USD



LED Şerit
LED Strip

AC 220V - SMD 2835 120 LED Yanlara Bükülebilir / Dış Ortam

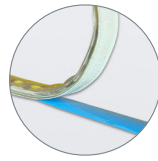

YAPIŞKANLI

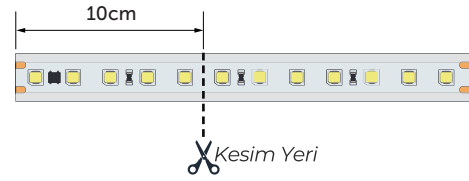
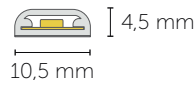

Kod Code	Işık Rengi CCT	Miktar/Koli Quantity/Carton	Fiyat Price
4334	01 6500K	100 mt	3,15 USD
	02 3000K		
	03 Kırmızı		
	04 Yeşil		
	05 Mavi		
	07 4000K		
	08 Amber		

Bir koli 4 adet bağlantı fişi +10 adet uç kapak içerir.

Bağlantı Kablosu
Power Cable

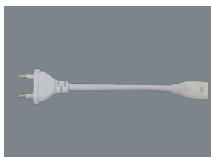

Kod / Code	1130
Koli / Carton	1
Fiyat / Price	2,00 USD

Uç Kapak
End Cap

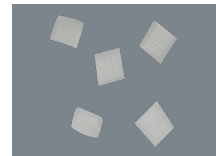

Kod / Code	1131
Koli / Carton	50
Fiyat / Price	0,25 USD



Neon LED
Neon LED

AC 220V - SMD 2835 120 LED / Dış Ortam

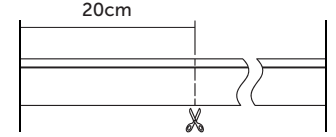
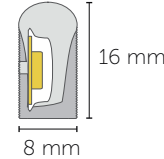
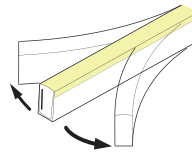

Sağa ve sola 2 eksenli bükülebilme



Kod Code	Işık Rengi CCT	Miktar/Koli Quantity/Carton	Fiyat Price
4340	01 6500K	2 x 50 mt	6,50 USD
	02 3000K		
	03 Kırmızı		
	04 Yeşil		
	05 Mavi		13,00 USD
	06 RGB		
	07 4000K		
	08 Amber		

Bir koli 4 adet bağlantı fişi +10 adet uç kapak içerir.

Bağlantı Kablosu Power Cable		Kod / Code	1150
		Koli / Carton	1
		Fiyat / Price	5,50 USD

Uç Kapak End Cap		Kod / Code	1151
		Koli / Carton	10
		Fiyat / Price	0,20 USD

Ara Bağlantı Aparatı
Interconnection Pin

	Kod / Code	1153
	Koli / Carton	10
	Fiyat / Price	0,85 USD

Sabitleme Aparatı Fixing Clip		Kod / Code	1152
		Koli / Carton	10
		Fiyat / Price	0,20 USD

RGB Bağlantı Kablosu
RGB Power Cable

	Kod / Code	1155
	Koli / Carton	1
	Fiyat / Price	9,00 USD



Neon LED
Neon LED

AC 220V - SMD 2835 120 LED 3 Eksende Bükülebilir / Dış Ortam

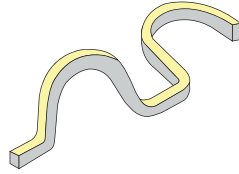

Sağa, sola ve aşağı yönde 3 eksenli bükülebilir

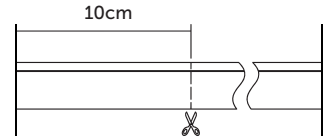
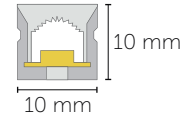

3
YIL
GARANTİ

120
LED/m

10
W/m

AC
220 V

880
Lm/m

CRI
≥80

35,000
h.

IP65



Kod Code	Işık Rengi CCT	Miktar/Koli Quantity/Carton	Fiyat Price
4341	01 6500 K	4 x 25 mt	22,00 USD
	02 3000 K		
	07 4000 K		
	08 Amber		

Bir koli 4 adet bağlantı fişi +20 adet uç kapak 4 adet 30cm köşe dönüş aparatı içerir.

Bağlantı Kablosu
Power Cable



Kod / Code	1135
Koli / Carton	1
Fiyat / Price	2,50 USD

Sabitlenme Aparatı
Fixing Clip

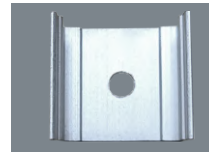

Kod / Code	1137
Koli / Carton	10
Fiyat / Price	0,25 USD

Uç Kapak
End Cap



Kod / Code	1136
Koli / Carton	10
Fiyat / Price	0,40 USD

Köşe Dönüş Aparatı
Corner bracket

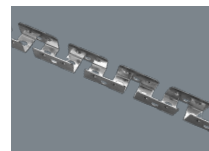

Kod / Code	1138
Koli / Carton	4
Fiyat / Price	1,40 USD



Neon LED
Neon LED

DC 12V - SMD 2835 120 LED Yanlara Bükülebilir / Dış Ortam

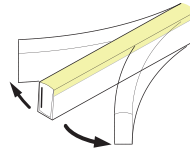

Sağa ve sola 2 ekseni bükülebilir

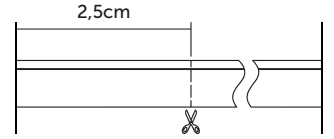
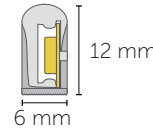

Kod Code	Işık Rengi CCT	Miktar/Koli Quantity/Cartron	Fiyat Price
4342	01 6500K	100 mt	5,20 USD
	02 3000K		
	03 Kırmızı		
	04 Yeşil		9,00 USD
	05 Mavi		
	06 RGB		
	07 4000K		
	08 Amber		5,20 USD
	09 Buz Mavi		
	10 Pembe		

Bir koli 5 adet bağlantı fişi +10 adet uç kapak içerir.

Bağlantı Kablosu
Power Cable



Kod / Code	1156
Koli / Carton	1
Fiyat / Price	1,60 USD

Sabitleme Aparatı
Fixing Clip

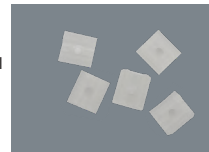

Kod / Code	1158
Koli / Carton	10
Fiyat / Price	0,20 USD

Ara Bağlantı Aparatı
Interconnection Pin



Kod / Code	1157
Koli / Carton	10
Fiyat / Price	2,20 USD

Uç Kapak
End Cap



Kod / Code	1159
Koli / Carton	10
Fiyat / Price	0,20 USD



- Epoksi kaplama sayesinde güçlü dış etki koruması
- Kısa devre ve aşırı yükte entegre güvenlik sistemi
- Klemensli terminal yapısı ile pratik montaj
- 12V ve 24V alternatifli güç çözümleri
- Yüksek verimli ve dengeli çalışma performansı



5 metre
120LED/m

5A

Ürün Kodu	Giriş	Çıkış	Güç	Koli Adeti
1202	AC220V	DC12V	60W	100

Boyutlar : 113x50x22

8,70 USD



10 metre
120LED/m

10A

Ürün Kodu	Giriş	Çıkış	Güç	Koli Adeti
1204	AC220V	DC12V	120W	100

Boyutlar : 138x50x22

11,50 USD



13 metre
120LED/m

12,5A

Ürün Kodu	Giriş	Çıkış	Güç	Koli Adeti
1205	AC220V	DC12V	150W	50

Boyutlar : 178x50x22

14,00 USD



17 metre
120LED/m

16,6A

Ürün Kodu	Giriş	Çıkış	Güç	Koli Adeti
1206	AC220V	DC12V	200W	50

Boyutlar : 178x50x22

16,00 USD

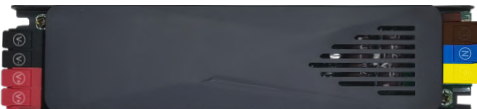

21 metre
120LED/m

20,8A

Ürün Kodu	Giriş	Çıkış	Güç	Koli Adeti
1207	AC220V	DC12V	250W	50

Boyutlar : 205x50x22

18,50 USD



30 metre
120LED/m

30A

Ürün Kodu	Giriş	Çıkış	Güç	Koli Adeti
1209	AC220V	DC12V	360W	50

Boyutlar : 238x50x22

21,00 USD

14 metre
SCOB

5A



Ürün Kodu	Giriş	Güç	Koli Adeti
1212	AC220V	120W	100

Boyutlar : 138x50x22

12,00 USD

28 metre
SCOB

10A



Ürün Kodu	Giriş	Güç	Koli Adeti
1214	AC220V	250W	50

Boyutlar : 205x50x22

18,50 USD

40 metre
SCOB

15A



Ürün Kodu	Giriş	Güç	Koli Adeti
1216	AC220V	360W	50

Boyutlar : 238x50x22

22,50 USD

RGB Kumandalar RGB Controllers



Kod Code	Algı Mesafesi Detection Dis.	Adet/Koli Pcs/Carton	Fiyat Price
3012	20 m	50	8,00 USD



Kod Code	Algı Mesafesi Detection Dis.	Adet/Koli Pcs/Carton	Fiyat Price
3014	20 m	50	14,00 USD



Kod Code	Algı Mesafesi Detection Dis.	Adet/Koli Pcs/Carton	Fiyat Price
3016	20 m	50	12,00 USD



Kod Code	Algı Mesafesi Detection Dis.	Adet/Koli Pcs/Carton	Fiyat Price
3019	10 m	100	4,40 USD



Aydınlatma Kumandalar Lighting Controllers



Kod Code	Algı Mesafesi Detection Dis.	Tip Type	Adet/Koli Pcs/Carton	Fiyat Price
3213	20 m	3	50	11,50 USD

Kod Code	Algı Mesafesi Detection Dis.	Tip Type	Adet/Koli Pcs/Carton	Fiyat Price
3214	20 m	4	50	12,50 USD



Kod Code	Algı Mesafesi Detection Dis.	Tip Type	Adet/Koli Pcs/Carton	Fiyat Price
3216	20 m	6	50	15,50 USD

1000W Enkandesen Lamba
200W LED Armatür
200W Floresan Lamba





LED Acil Çıkış
LED Emergency Exit



Kod Code	Güç Power	Gerilim Voltage	Acil Aydınlatma Emergency Light	Adet/Koli Pcs/Carton	Fiyat Price
5120	1 W	AC 220V 240V	4 Saat	20	11,00 USD



Kod Code	Güç Power	Gerilim Voltage	Acil Aydınlatma Emergency Light	Adet/Koli Pcs/Carton	Fiyat Price
5121	1 W	AC 220V 240V	4 Saat	20	11,00 USD



Kod Code	Güç Power	Gerilim Voltage	Acil Aydınlatma Emergency Light	Adet/Koli Pcs/Carton	Fiyat Price
5122	1 W	AC 220V 240V	4 Saat	20	11,00 USD



Kod Code	Güç Power	Gerilim Voltage	Acil Aydınlatma Emergency Light	Adet/Koli Pcs/Carton	Fiyat Price
5123	1 W	AC 220V 240V	4 Saat	20	11,00 USD

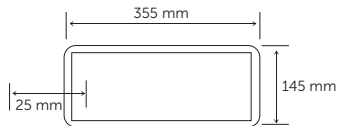

Acil aydınlatma süresi 4 saattir.



Zaman saatleri ve Acil durum kiti

Timers and Emergency kit

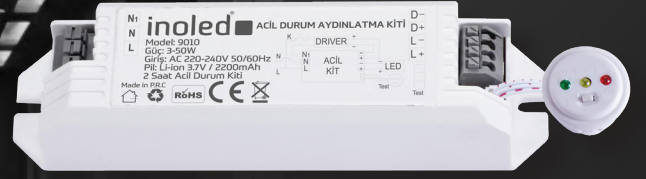

Zaman Saatleri Timers



Kod Code	Tip Type	Adet/Koli Pcs/Carton	Fiyat Price
3070	Mekanik	50	9,20 USD

Kod Code	Tip Type	Adet/Koli Pcs/Carton	Fiyat Price
3073	Dijital	50	16,00 USD



Kod Code	Tip Type	Adet/Koli Pcs/Carton	Fiyat Price
3080	W Otomat	100	17,50 USD

16 A | IP20

Acil Durum Işıldak Emergency Lanterns

GUARD

SANTOS



Ürün Kodu	Pil	Güç	Koli Adeti
3093-01	6V/4.5 A	2x10W	5
Metal Kasa - 3 Saat		190,00 USD	



Ürün Kodu	Pil	Güç	Koli Adeti
3092-01	6V/4.5 A	2x10W	10
Plastik Kasa - 3 Saat		90,00 USD	

3 YIL
GARANTİ

3 YIL
GARANTİ

Acil Durum Kit Emergency Kit



Kod Code	Güç Power	Acil Aydınlatma Emergency Light	Adet/Koli Pcs/Carton	Fiyat Price
9010	3 W	2 Saat	50	15,00 USD



Sensörlü LED Aplık
LED Sensor Applique

ARIA



Güç Power	Kod Code	Opsiyonlar Options	Işık Akısı Lumen	Işık Rengi CCT	Adet/Koli Pcs/Carton	Fiyat Price
18 W	5178	PIR Sensör)))	1300 lm	03 4000K	20	29,00 USD
	5178-K	PIR Sensör))) Acil Kit	1300 lm		20	40,00 USD

Montaj Yüksekliği: 1,8m-2,5m

Algı Mesafesi : 9m

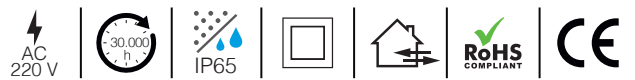
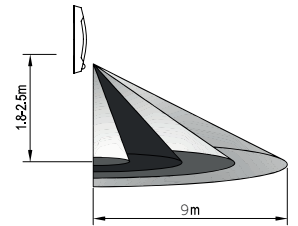
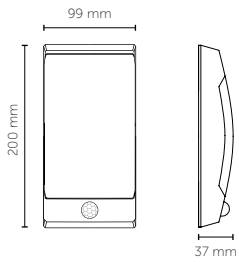

inoled



Kod Code	Sensör Tipi Sensor Type	Güç Power	Işık Rengi CCT	Işık Akısı Lumen	Adet/Koli Pcs/Carton	Fiyat Price
5150	PIR Sensör)))	15 W	03 4000K	1500	20	37,00 USD

Montaj Yüksekliği: 1,8m-2,5m Algı Mesafesi : 9m

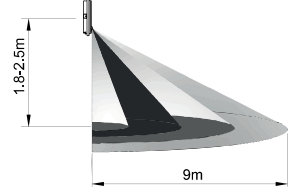
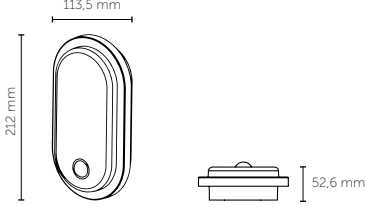

ORBIS



Kod Code	Sensör Tipi Sensor Type	Güç Power	Işık Rengi CCT	Işık Akısı Lumen	Adet/Koli Pcs/Carton	Fiyat Price
5152	PIR Sensör)))	15 W	03 4000K	1500	10	45,00 USD

Montaj Yüksekliği: 1,8m-2,5m Algı Mesafesi : 9m

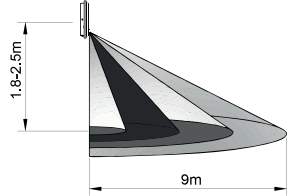
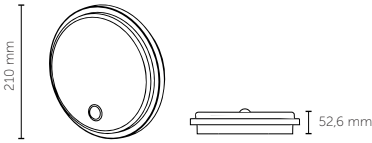

ARKUS



Kod Code	Sensör Tipi Sensor Type	Güç Power	Işık Rengi CCT	Işık Akısı Lumen	Adet/Koli Pcs/Carton	Fiyat Price
5154	PIR Sensör)))	12 W	03 4000K	1300	20	52,00 USD
		15 W		1600		
		20 W		2100		

Montaj Yüksekliği: 1,8m-2,5m Algı Mesafesi : 9m

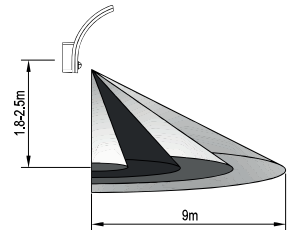
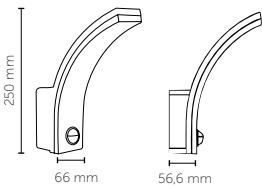

LIERA

LED Tavan Armatür
LED Ceiling Luminaire

YIL
3
GARANTİ

YENİ
ÜRÜN

100 Lm/W

ABS GÖVDE

AYARLANABİLİR SENSÖR

IP40



Güç Power	Kod Code	Opsiyonlar Options	Işık Akısı Lumen	Işık Rengi CCT	Adet/Koli Pcs/Carton	Fiyat Price
18 W	5170		1800 lm	01 02 03 6500K 3000K 4000K	20	14,00 USD



18 W	5173		1800 lm	01 02 03 6500K 3000K 4000K	20	15,00 USD
------	------	--	---------	-------------------------------	----	-----------

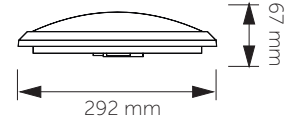

Sensörlü LED Tavan Armatür
Sensor LED Ceiling Luminaire



Güç Power	Kod Code	Opsiyonlar Options	Işık Akısı Lumen	Işık Rengi CCT	Adet/Koli Pcs/Carton	Fiyat Price
18 W	5171	PIR Sensör)))	1800 lm	01 02 03 6500K 3000K 4000K	20	18,50 USD
	5171-K	PIR Sensör))) Acil Kit	1800 lm		20	26,00 USD



18 W	5174	PIR Sensör)))	1800 lm	01 02 03 6500K 3000K 4000K	20	19,50 USD
	5174-K	PIR Sensör))) Acil Kit	1800 lm		20	27,00 USD



18 W	5172	Radar Sensör)))	1800 lm	01 02 03 6500K 3000K 4000K	20	18,50 USD
	5172-K	Radar Sensör))) Acil Kit	1800 lm		20	26,00 USD



18 W	5175	Radar Sensör)))	1800 lm	01 02 03 6500K 3000K 4000K	20	19,50 USD
	5175-K	Radar Sensör))) Acil Kit	1800 lm		20	27,00 USD

Acil aydınlatma süresi 3 saattir.

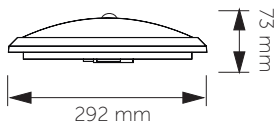

LED Tavan Armatür LED Ceiling Luminaire



Güç Power	Kod Code	Opsiyonlar Options	Işık Akısı Lumen	Işık Rengi CCT	Adet/Koli Pcs/Carton	Fiyat Price
18 W	5162		1260 lm	01 02 03 6500K 3000K 4000K	10	18,00 USD

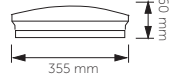

28 W	5164		1960 lm	01 02 03 6500K 3000K 4000K	10	25,50 USD
------	------	--	---------	--	----	-----------

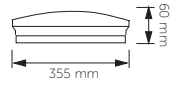

Sensörlü LED Tavan Armatür Sensor LED Ceiling Luminaire



Güç Power	Kod Code	Opsiyonlar Options	Işık Akısı Lumen	Işık Rengi CCT	Adet/Koli Pcs/Carton	Fiyat Price
18 W	5163	Radar Sensör)))	1260 lm	01 02 03 6500K 3000K 4000K	10	24,0 USD
	5169	Radar Sensör))) Acil Kit	1260 lm		10	47,00 USD

Acil aydınlatma süresi 2 saattir.

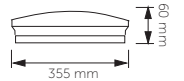

Sensörler
Sensors

YIL
3
GARANTİ



Kod Code	Montaj Tipi Assembly Type	Sensör Tipi Sensor Type	Algılama Açısı Detecting Angle	Adet/Koli Pcs/Carton	Fiyat Price
5130	Duvar	IR	180 °	50	11,20 USD

Montaj Yüksekliği: 1,8m-2,5m Algı Mesafesi : 12m
Çalışma Zaman Aralığı: 10sn ±3sn / 15dk ±2dk(Ayarlanabilir)
Lux aydınlatma seviyesi ayarı : <3-2000LUX (Ayarlanabilir)

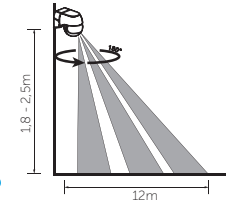

Kod Code	Montaj Tipi Assembly Type	Sensör Tipi Sensor Type	Algılama Açısı Detecting Angle	Adet/Koli Pcs/Carton	Fiyat Price
5131	Tavan	IR	360 °	50	11,20 USD

Montaj Yüksekliği: 2,2m-4m Algı Mesafesi : 6m
Çalışma Zaman Aralığı: 10sn ±3sn / 15dk ±2dk(Ayarlanabilir)
Lux aydınlatma seviyesi ayarı : <3-2000LUX (Ayarlanabilir)

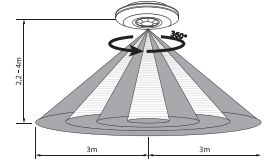

Kod Code	Sensör Tipi Sensor Type	Algılama Açısı Detecting Angle	Adet/Koli Pcs/Carton	Fiyat Price
5132	IR	360 °	50	11,20 USD

Montaj Yüksekliği: 2,2m-4m Algı Mesafesi : 6m
Çalışma Zaman Aralığı: 5sn, 30sn, 1dk, 3dk, 5dk, 8dk (Ayarlanabilir)
Lux aydınlatma seviyesi ayarı : 10LUX / 2000LUX (Ayarlanabilir)

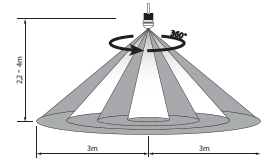

Kod Code	Montaj Tipi Assembly Type	Sensör Tipi Sensor Type	Algılama Açısı Detecting Angle	Adet/Koli Pcs/Carton	Fiyat Price
5133	Tavan	IR	360 °	50	11,20 USD

Montaj Yüksekliği: 2,2m-4m Algı Mesafesi : 6m
Çalışma Zaman Aralığı: 10sn ±3sn / 15dk ±2dk(Ayarlanabilir)
Lux aydınlatma seviyesi ayarı : <3-2000LUX (Ayarlanabilir)

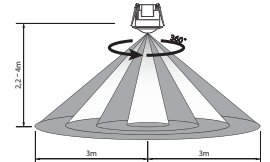

Kod Code	Sensör Tipi Sensor Type	Algılama Açısı Detecting Angle	Adet/Koli Pcs/Carton	Fiyat Price
5134	RF	360 °	50	14,50 USD

Montaj Yüksekliği: 2,2m-4m Algı Mesafesi : 16m
Çalışma Zaman Aralığı: Min. 10 sn ± 3 sn, Maks. 12 dk ± 1dk (Ayarlanabilir)
Lux aydınlatma seviyesi ayarı : <3-2000LUX (Ayarlanabilir)

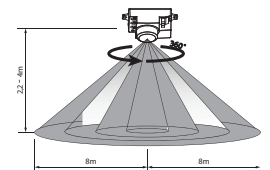

inoled

Koridor Armatürler
Step Lights





Kod Code	Güç Power	Işık Rengi CCT	Işık Akısı Lumen	Rengi Housing C.	Adet/Koli Pcs/Carton	Fiyat Price
6106	1 W	01 6500K 02 3000K 03 Mavi	40 lm	Siyah	50	11,80 USD

RINO

Kod Code	Güç Power	Işık Rengi CCT	Işık Akısı Lumen	Rengi Housing C.	Adet/Koli Pcs/Carton	Fiyat Price
6101	1 W	01 6500K 02 3000K 03 Mavi	40 lm	Beyaz	50	10,60 USD

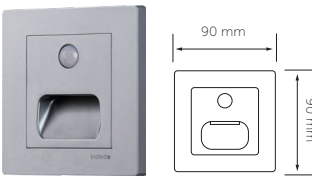
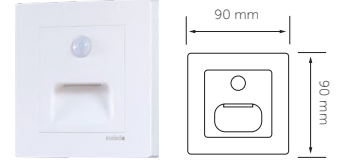

Kod Code	Güç Power	Işık Rengi CCT	Işık Akısı Lumen	Rengi Housing C.	Adet/Koli Pcs/Carton	Fiyat Price
6102	1 W	01 6500K 02 3000K 03 Mavi	40 lm	Gri	50	10,80 USD

Kod Code	Güç Power	Işık Rengi CCT	Işık Akısı Lumen	Rengi Housing C.	Adet/Koli Pcs/Carton	Fiyat Price
6103	1 W	01 6500K 02 3000K 03 Mavi	40 lm	Siyah	50	10,80 USD

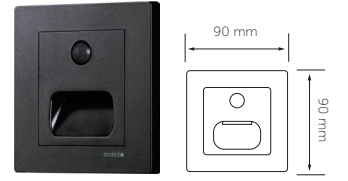

CLASSY

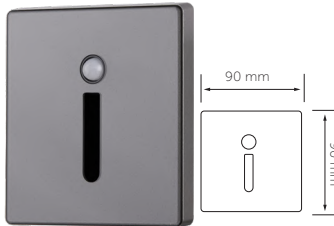

Kod Code	Güç Power	Işık Rengi CCT	Işık Akısı Lumen	Rengi Housing C.	Adet/Koli Pcs/Carton	Fiyat Price
6104	1.5 W	01 6500K 02 3000K	60 lm	Antrasit	50	20,00 USD

RINO

Kod Code	Güç Power	Işık Rengi CCT	Işık Akısı Lumen	Rengi Housing C.	Adet/Koli Pcs/Carton	Fiyat Price
6105	1 W	01 6500K 02 3000K 03 Mavi	40 lm	Siyah	50	9,30 USD

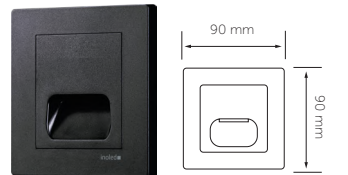

Ek özellikler;
- PHOTOCCELL
- Geçmeli kasaya uygundur



EGRA

LED Projektörler *LED Floodlights*

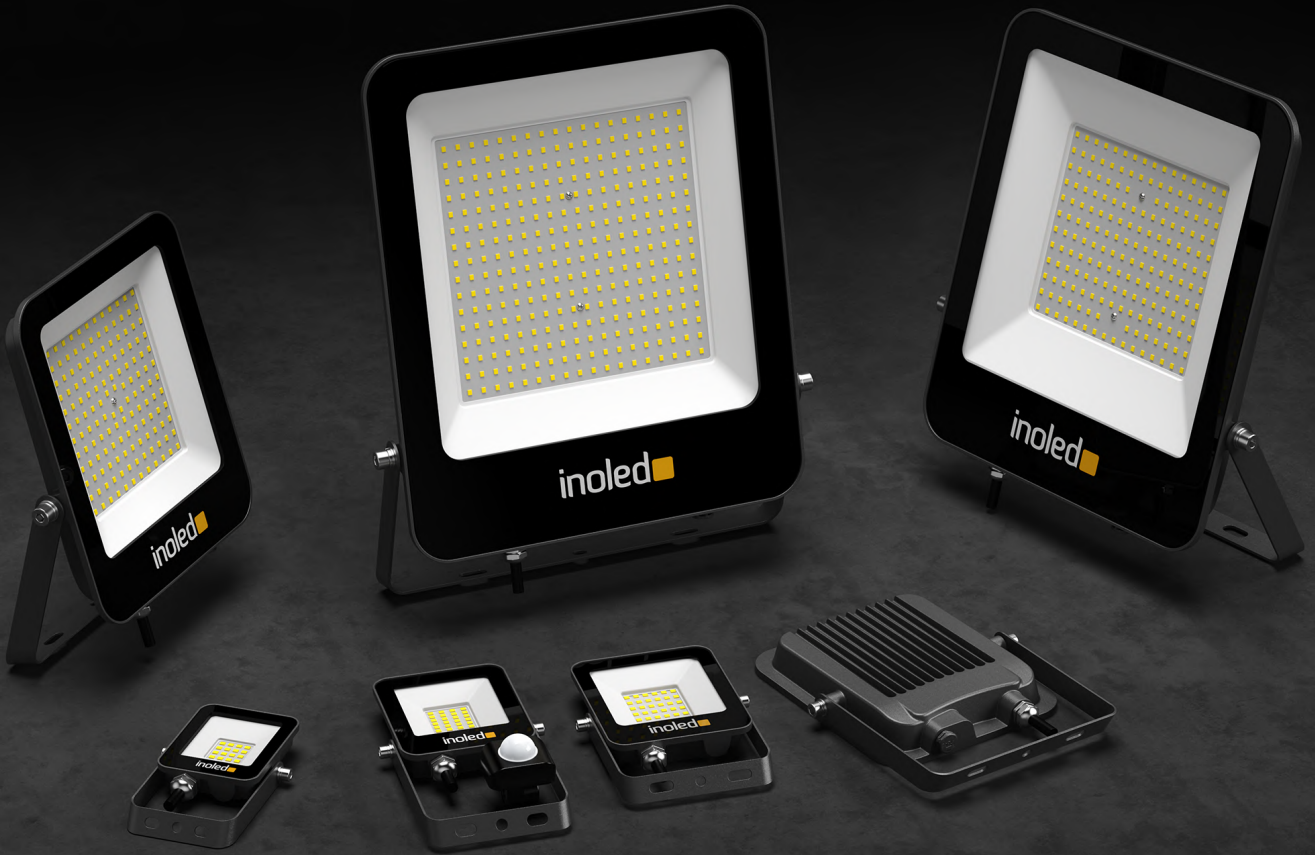

130 Lm/W





ADC12 ALÜMİNYUM GÖVDE

IP66

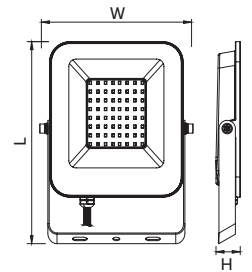



Kod Code	Güç Power	Boyutlar W x L x H	Işık Akısı Lumen	Işık Rengi CCT	Adet/Koli Pcs/Carton	Fiyat Price
7201	10 W	89 x 131 x 22 mm	1300 lm	01 6500K	24	11,50 USD
				02 3000K		
				04 Yeşil		
				05 Mavi		
				08 Amber		
7202	20 W	105x 138 x 20 mm	2600 lm	01 6500K	24	15,50 USD
				02 3000K		
				04 Yeşil		
				05 Mavi		
				08 Amber		
7203	30 W	117x 154 x 25 mm	3900 lm	01 6500K	20	21,00 USD
				02 3000K		
				04 Yeşil		
				05 Mavi		
				08 Amber		
7205	50 W	164x 221 x 26 mm	6500 lm	01 6500K	20	26,50 USD
				02 3000K		
				03 4000K		
				04 Yeşil		
				08 Amber		

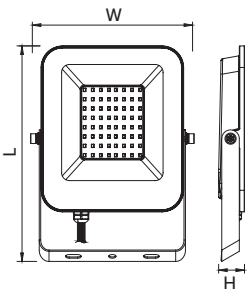

	Kod Code	Güç Power	Boyutlar W x L x H	Işık Akısı Lumen	Işık Rengi CCT	Adet/Koli Pcs/Carton	Fiyat Price
	7210	100 W	227 x 279 x 28 mm	13000 lm	01 6500K	10	45,00 USD
					02 3000K		
					03 4000K		
	7215	150 W	300 x 380 x 37 mm	19500 lm	01 6500K	5	85,00 USD
					02 3000K		
	7220	200 W	320 x 406 x 38 mm	26000 lm	01 6500K	5	102,00 USD
					02 3000K		
	7240	400 W	420 x 509 x 42 mm	52000 lm	01 6500K	3	260,00 USD
					02 3000K		



	Kod Code	Güç Power	Boyutlar W x L x H	Işık Akısı Lumen	Işık Rengi CCT	Adet/Koli Pcs/Carton	Fiyat Price
	7222	20 W	109 x 184 x 48 mm	2600 lm	01 6500K	20	35,00 USD
					02 3000K		
	7223	30 W	117 x 196 x 52 mm	3900 lm	01 6500K	20	40,00 USD
					02 3000K		
	7225	50 W	168 x 252 x 54 mm	6500 lm	01 6500K	12	48,00 USD
					02 3000K		

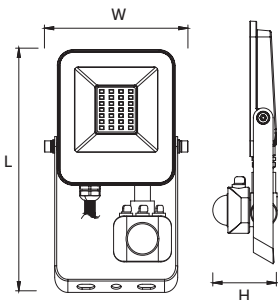

FORTIS

LED Projektörler *LED Floodlights*

5
YIL
GARANTİ

YENİ
ÜRÜN

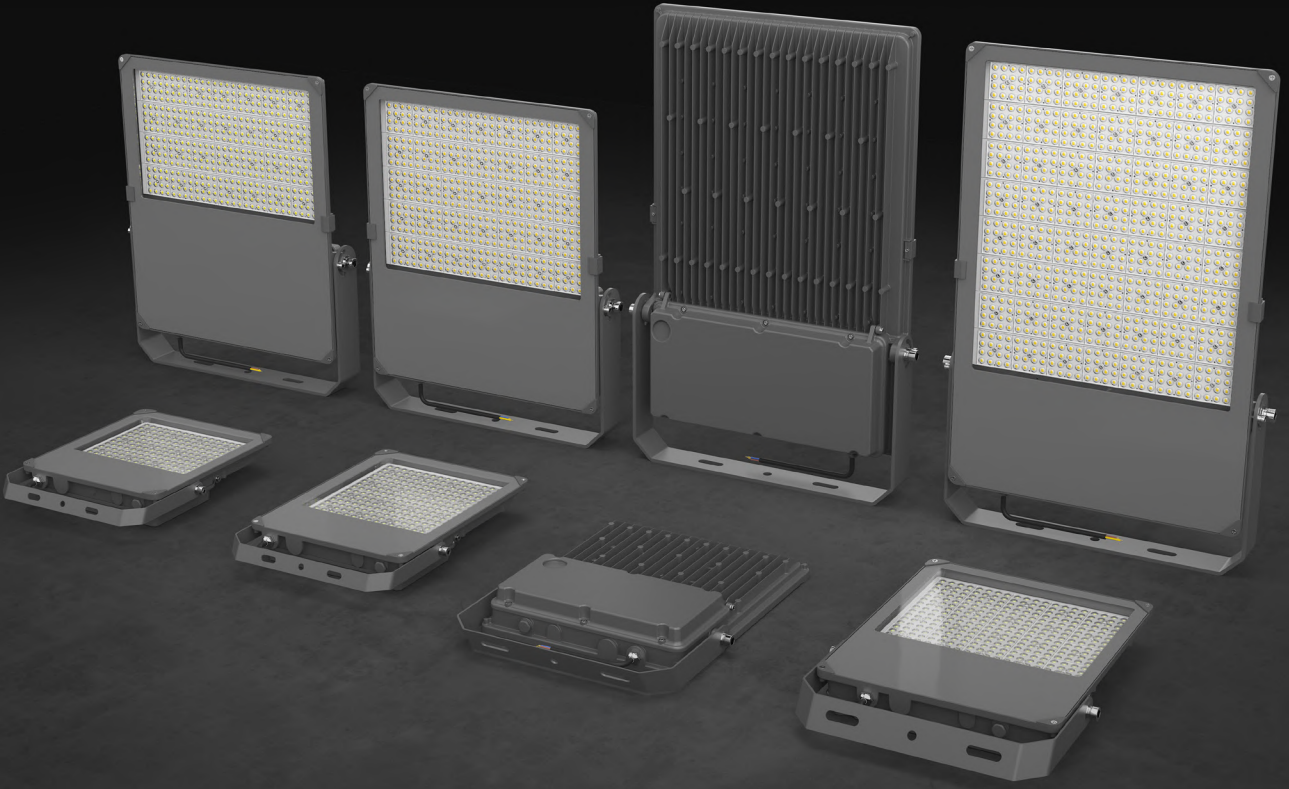

150 Lm/W

ALÜMİNYUM GÖVDE

IP66

ENEC SÜRÜCÜ

Kod Code	Güç Power	Boyutlar W x L x H	Işık Akısı Lumen	Işık Rengi CCT	Adet/Koli Pcs/Carton	Fiyat Price
7305	50 W	284 x 326 x 59 mm	7500 lm	01 03 6500K 4000K	1	140,00 USD
7307	70 W	284 x 326 x 59 mm	10500 lm	01 03 6500K 4000K	1	150,00 USD
7310	100 W	284 x 326 x 59 mm	15000 lm	01 03 6500K 4000K	1	160,00 USD
7315	150 W	284 x 376 x 59 mm	22500 lm	01 03 6500K 4000K	1	190,00 USD
7320	200 W	333 x 435 x 61 mm	30000 lm	01 03 6500K 4000K	1	250,00 USD
7330	300 W	445 x 521 x 73 mm	45000 lm	01 03 6500K 4000K	1	420,00 USD
7340	400 W	445 x 521 x 73 mm	60000 lm	01 03 6500K 4000K	1	530,00 USD
7350	500 W	445 x 671 x 73 mm	75000 lm	01 03 6500K 4000K	1	750,00 USD
7360	600 W	445 x 671 x 73 mm	90000 lm	01 03 6500K 4000K	1	880,00 USD

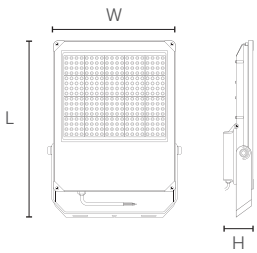

ORIA

LED Sokak Armatür
LED Street Luminaire

130 Lm/W

ADC12 ALÜMİNYUM GÖVDE

IP65

LED Sokak Armatür
LED Street Light

ORIA

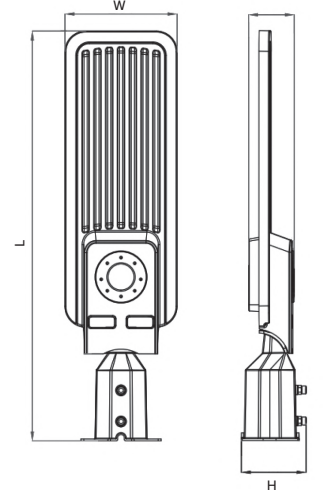
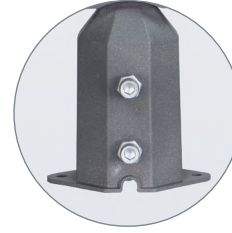

Kod Code	Güç Power	Boyutlar W x L x H	Işık Akısı Lumen	Işık Rengi CCT	Adet/Koli Pcs/Carton	Fiyat Price	
7601	50 W	120 x 456 x 83 mm	6500 lm	<input type="radio"/> 01 6500K	<input type="radio"/> 03 4000K	8	50,00 USD
7602	100 W	144 x 527 x 83 mm	13000 lm	<input type="radio"/> 01 6500K	<input type="radio"/> 03 4000K	8	70,00 USD
7603	150 W	175 x 618 x 85 mm	19500 lm	<input type="radio"/> 01 6500K	<input type="radio"/> 03 4000K	8	100,00 USD



PF
≥0,95

130
Lm/W



RoHS
COMPLIANT



LUMAX

LED Solar Sokak Armatür
LED Solar Street Luminaire



UZUN PİL ÖMRÜ

ÖZEL DEŞARJ EĞRİSİ

OPTİK LENS



Kod Code	Güç Power	Işık Akısı Lumen	Işık Rengi CCT	Adet/Koli Pcs/Carton	Fiyat Price
9381	100 W	2100 lm	01 6500K	10	60,00 USD

Şarj Süresi: 4-6 Saat
Çalışma Süresi: 14 Saat

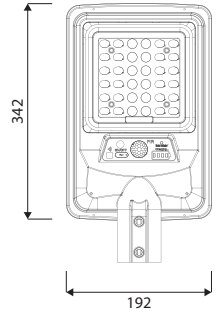

Kod Code	Güç Power	Işık Akısı Lumen	Işık Rengi CCT	Adet/Koli Pcs/Carton	Fiyat Price
9382	200 W	3100 lm	01 6500K	10	90,00 USD

Şarj Süresi: 4-6 Saat
Çalışma Süresi: 14 Saat

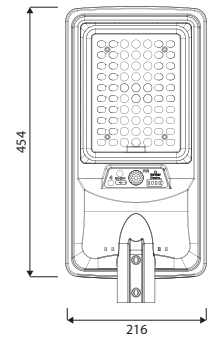



LED Solar Sokak Armatürler
LED Solar Street Luminaire

LUMAX



Kod Code	Güç Power	Işık Akısı Lumen	Işık Rengi CCT	Adet/Koli Pcs/Carton	Fiyat Price
9383	300 W	4200 lm	01 6500K	5	115,00 USD

Şarj Süresi: 4-6 Saat
Çalışma Süresi: 14 Saat

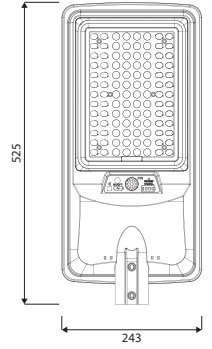

Kod Code	Güç Power	Işık Akısı Lumen	Işık Rengi CCT	Adet/Koli Pcs/Carton	Fiyat Price
9385	500 W	6000 lm	01 6500K	5	170,00 USD

Şarj Süresi: 4-6 Saat
Çalışma Süresi: 14 Saat

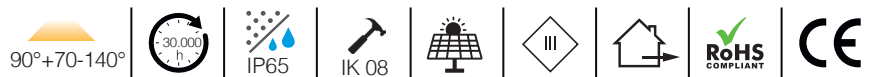
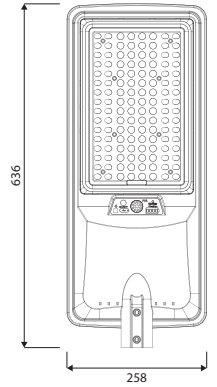



Kod Code	Güç Power	Işık Akısı Lumen	Işık Rengi CCT	Adet/Koli Pcs/Carton
9355	50 W	700 Lm	01 6500K	10
Boyutlar : 300 x 217 mm				53,00 USD

Kod Code	Güç Power	Işık Akısı Lumen	Işık Rengi CCT	Adet/Koli Pcs/Carton
9356	100 W	1300 Lm	01 6500K	10
Boyutlar : 401 x 236 mm				70,00 USD



Kod Code	Güç Power	Işık Akısı Lumen	Işık Rengi CCT	Adet/Koli Pcs/Carton
9357	200 W	2300 Lm	01 6500K	6
Boyutlar : 502 x 236 mm				105,00 USD

Kod Code	Güç Power	Işık Akısı Lumen	Işık Rengi CCT	Adet/Koli Pcs/Carton
9358	300 W	3100 Lm	01 6500K	6
Boyutlar : 601 x 236 mm				125,00 USD



Kod Code	Güç Power	Işık Akısı Lumen	Işık Rengi CCT	Adet/Koli Pcs/Carton
9359	400 W	3700 Lm	01 6500K	5
Boyutlar : 750 x 238 mm				145,00 USD

Kod Code	Güç Power	Işık Akısı Lumen	Işık Rengi CCT	Adet/Koli Pcs/Carton
9365	600 W	5000 Lm	01 6500K	1
Boyutlar : 650 x 312 mm				250,00 USD

Kod Code	Güç Power	Işık Akısı Lumen	Işık Rengi CCT	Adet/Koli Pcs/Carton
9366	800 W	6000 Lm	01 6500K	1
Boyutlar : 816 x 348 mm				310,00 USD





5
YIL
GARANTİ

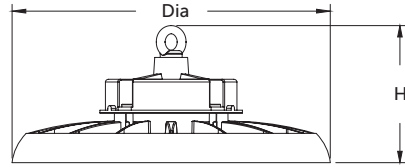
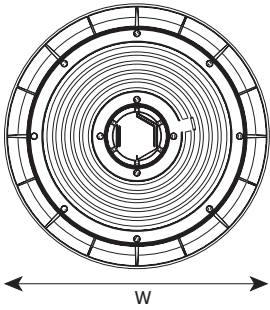

EN
EC
sürücü

Kod Code	Güç Power	Boyutlar W x L x H	Surge	Işık Akısı Lumen	Işık Rengi CCT	Adet/Koli Pcs/Carton	Fiyat Price
7522	100 W	Ø 265 x 146 mm	>6KV	15000 lm	01 6500K	4	165,00 USD
7524	150 W	Ø 290 x 150 mm	>8KV	22500 lm	01 6500K	4	185,00 USD
7526	200 W	Ø 346 x 152 mm	>8KV	30000 lm	01 6500K	4	240,00 USD



PF
≥0,95

150
Lm/W



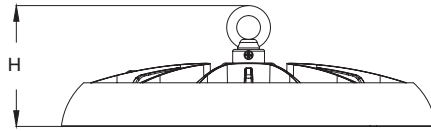
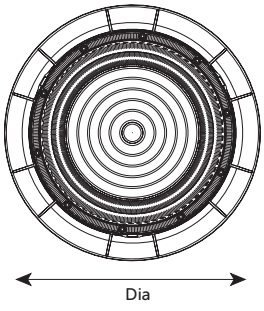

Kod Code	Güç Power	Boyutlar W x L x H	Surge	Işık Akısı Lumen	Işık Rengi CCT	Adet/Koli Pcs/Carton	Fiyat Price
7512	100 W	Ø 270 x 91 mm	>6KV	13500 lm	01 6500K	8	67,00 USD
7514	150 W	Ø 300 x 96,5 mm	>8KV	20250 lm	01 6500K	8	87,00 USD
7516	200 W	Ø 330 x 103 mm	>8KV	27000 lm	01 6500K	8	110,00 USD



ENDURA

Yüksek Tavan Armatürü
Highbay Luminaire

3
YIL
GARANTİ

YENİ
ÜRÜN

140 Lm/W

ALÜMİNYUM GÖVDE

OPTİK LENS

Kod Code	Güç Power	Boyutlar W x L x H	Işık Rengi CCT	Işık Akısı Lumen	Adet/Koli Pcs/Carton	Fiyat Price
5270	70 W	156 x 380 x 50 mm	01 6500K	9800 lm	6	160,00 USD
			02 3000K			
			03 4000K			
5271	100 W	156 x 475 x 50 mm	01 6500K	14000 lm	6	190,00 USD
			02 3000K			
			03 4000K			
5272	120 W	156 x 570 x 50 mm	01 6500K	16800 lm	4	210,00 USD
			02 3000K			
			03 4000K			
5273	150 W	156 x 660 x 50 mm	01 6500K	21000 lm	4	240,00 USD
			02 3000K			
			03 4000K			
5274	175 W	156 x 760 x 50 mm	01 6500K	24500 lm	3	300,00 USD
			02 3000K			
			03 4000K			
5275	200 W	156 x 760 x 50 mm	01 6500K	28000 lm	3	330,00 USD
			02 3000K			
			03 4000K			
5276	250 W	156 x 860 x 50 mm	01 6500K	35000 lm	2	400,00 USD
			02 3000K			
			03 4000K			

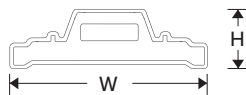
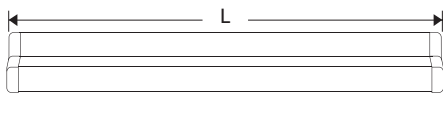

Montaj Şekilleri

- Sıva Üstü
- Busbar
- Duvar
- Tavan Askı

30° 90° ASİMETRİK

OSRAM LED

LIFUD

TEMPERLİ CAM LENSİLİ TASARIM

Opsiyonlar | DALI (1-10V)
ACİL KİT



PF
≥0,95

140
Lm/W





LED Aplikler LED Appliques

Kod Code	Güç Power	Gövde Rengi Housing Color	Işık Rengi CCT	Işık Akısı Lumen	Adet/Koli Pcs/Carton	Fiyat Price
6202	6 W	Krom / Chromium	<div style="display: flex; justify-content: space-around;"> <div style="border: 1px solid black; border-radius: 50%; padding: 2px;">01</div> <div style="border: 1px solid black; border-radius: 50%; padding: 2px;">02</div> </div> 6500K 3000K	540 Lm	20	23,00 USD
6203		Gold				
6204		Siyah / Black				
6205		Eskitme / Antiquing				

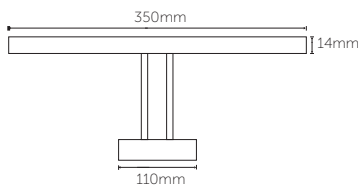

Dekoratif Armatürler
Decorative Luminaires





Dekoratif LED Aplikler
Decorative LED Apliques

MERITA

Reflektör Rengi
Reflector Color

Orange -01 

Siyah -02 

Beyaz - 03 

Gold - 04 

Platin - 05 

Bakır - 06 



Kod Code	Gövde Rengi Housing Color	Boyutlar Dia x H	Adet/Koli Pcs/Carton	Fiyat Price
9233-0X	Siyah /Black	Ø 60x100 mm	50	9,70 USD
9234-0X	Beyaz / White			
9235-0X	Bej / Beige			
9236-0X	Antrasit / Anthracite			

Kod Code	Gövde Rengi Housing Color	Boyutlar Dia x H	Adet/Koli Pcs/Carton	Fiyat Price
9237-0X	Siyah /Black	Ø 80x100 mm	50	11,40 USD
9238-0X	Beyaz / White			
9239-0X	Bej / Beige			
9240-0X	Antrasit / Anthracite			

Kod Code	Gövde Rengi Housing Color	Boyutlar Dia x H	Adet/Koli Pcs/Carton	Fiyat Price
9241-0X	Siyah /Black	Ø 100x100 mm	30	12,70 USD
9242-0X	Beyaz / White			
9243-0X	Bej / Beige			
9244-0X	Antrasit / Anthracite			

Dekoratif LED Aplikler
Decorative LED Apliques

LAREN

Reflektör Rengi
Reflector Color

Orange -01 

Siyah -02 

Beyaz - 03 

Gold - 04 

Platin - 05 

Bakır - 06 

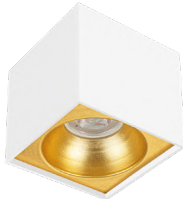

Kod Code	Gövde Rengi Housing Color	Boyutlar W x L x H	Adet/Koli Pcs/Carton	Fiyat Price
9245-0X	Siyah /Black	60x60x100 mm	50	10,60 USD
9246-0X	Beyaz / White			
9247-0X	Bej / Beige			
9248-0X	Antrasit / Anthracite			







Kod Code	Gövde Rengi Housing Color	Boyutlar W x L x H	Adet/Koli Pcs/Carton	Fiyat Price
9249-0X	Siyah /Black	80x80x100 mm	50	12,70 USD
9250-0X	Beyaz / White			
9251-0X	Bej / Beige			
9252-0X	Antrasit / Anthracite			

-Duy Armatüre Dahildir



Dekoratif LED Aplikler
Decorative LED Apliques





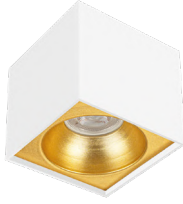

LAREN

Reflektör Rengi Reflector Color	Kod Code	Gövde Rengi Housing Color	Boyutlar W x L x H	Adet/Koli Pcs/Carton	Fiyat Price
Orange -01 	9253-0X	Siyah /Black	100x100x100 mm	30	14,80 USD
Siyah -02 	9254-0X	Beyaz / White			
	9255-0X	Bej / Beige			
	9256-0X	Antrasit / Anthracite			
Beyaz - 03 					
Gold - 04 	9257-0X	Siyah /Black	100x100x140 mm	30	16,30 USD
Platin - 05 	9258-0X	Beyaz / White			
	9259-0X	Bej / Beige			
	9260-0X	Antrasit / Anthracite			
Bakır - 06 					



Dekoratif LED Aplikler
Decorative LED Apliques

LIANA

Reflektör Rengi Reflector Color	Kod Code	Gövde Rengi Housing Color	Boyutlar W x L x H	Adet/Koli Pcs/Carton	Fiyat Price
Orange -01 	9261-0X	Siyah /Black	60x120x100 mm	30	23,30 USD
Siyah -02 	9262-0X	Beyaz / White			
	9263-0X	Bej / Beige			
	9264-0X	Antrasit / Anthracite			
Beyaz - 03 					
Gold - 04 	9265-0X	Siyah /Black	80x160x100 mm	30	27,50 USD
Platin - 05 	9266-0X	Beyaz / White			
	9267-0X	Bej / Beige			
	9268-0X	Antrasit / Anthracite			
Bakır - 06 					

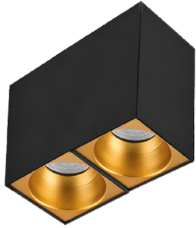

-Duy Armatüre Dahildir



Dekoratif LED Aplikler
Decorative LED Appliques

MARIUS



Kod Code	Gövde Rengi Housing Color	Boyutlar Dia x H	Adet/ Koli Pcs/Carton	Fiyat Price
9269-0X	Siyah /Black	Ø 60x200 mm	30	17,30 USD
9270-0X	Beyaz / White			
9271-0X	Bej / Beige			
9272-0X	Antrasit / Anthracite			
Kod Code	Gövde Rengi Housing Color	Boyutlar Dia x H	Adet/ Koli Pcs/Carton	Fiyat Price
9273-0X	Siyah /Black	Ø 60x300 mm	30	23,30 USD
9274-0X	Beyaz / White			
9275-0X	Bej / Beige			
9276-0X	Antrasit / Anthracite			



Dekoratif LED Aplikler
Decorative LED Appliques

NIFERA



Kod Code	Gövde Rengi Housing Color	Boyutlar Dia x H	Adet/ Koli Pcs/Carton	Fiyat Price
9277-0X	Siyah /Black	Ø 70x150 mm	30	21,20 USD
9278-0X	Beyaz / White			
9279-0X	Bej / Beige			
9280-0X	Antrasit / Anthracite			
Kod Code	Gövde Rengi Housing Color	Boyutlar Dia x H	Adet/ Koli Pcs/Carton	Fiyat Price
9281-0X	Siyah /Black	Ø 70x240 mm	30	26,20 USD
9282-0X	Beyaz / White			
9283-0X	Bej / Beige			
9284-0X	Antrasit / Anthracite			

-Duy Armatüre Dahildir







Kod Code	Gövde Rengi Housing Color	Boyutlar Dia x H	Adet/ Koli Pcs/Carton	Fiyat Price
9285	Siyah /Black	Ø 55x100 mm	50	12,20 USD
9286	Beyaz / White			
9287	Bej / Beige			
9288	Antrasit / Anthracite			

Reflektör Rengi
Reflector Color

Orange -01 

Siyah -02 

Beyaz - 03 

Gold - 04 

Platin - 05 

Bakır - 06 



Kod Code	Gövde Rengi Housing Color	Boyutlar Dia x H	Adet/ Koli Pcs/Carton	Fiyat Price
9289-0X	Siyah /Black	Ø 60x130 mm	50	17,00 USD
9290-0X	Beyaz / White			
9291-0X	Bej / Beige			
9292-0X	Antrasit / Anthracite			

-Duy Armatüre Dahildir



Linear LED Armatürler *Linear LED Luminaire*

3
YIL
GARANTİ

YENİ
ÜRÜN





Sıva Üstü Lineer LED Armatürler Surface Mounted Linear LED Luminaire

Kod Code	Uzunluk Length	Kasa Ebatları Case Dimensions	Güç Power	Işık Rengi CCT			Işık Akısı Lumen	Adet/Koli Pcs/Carton	Fiyat Price
5320	60 cm	38 x 82 mm	18 W	01 6500K	02 3000K	03 4000K	2160 Lm	1	40,00 USD
5321	100 cm	38 x 82 mm	30 W	01 6500K	02 3000K	03 4000K	3600 Lm	1	55,00 USD
5322	120 cm	38 x 82 mm	36 W	01 6500K	02 3000K	03 4000K	4320 Lm	1	63,00 USD



Kod Code	Uzunluk Length	Kasa Ebatları Case Dimensions	Güç Power	Işık Rengi CCT			Işık Akısı Lumen	Adet/Koli Pcs/Carton	Fiyat Price
5323	60 cm	50 x 82 mm	18 W	01 6500K	02 3000K	03 4000K	2160 Lm	1	44,00 USD
5324	100 cm	50 x 82 mm	30 W	01 6500K	02 3000K	03 4000K	3600 Lm	1	60,00 USD
5325	120 cm	50 x 82 mm	36 W	01 6500K	02 3000K	03 4000K	4320 Lm	1	68,00 USD

Opsiyonlar

DALI (1-10V)
ACİL KİT



PF
≥0,9

110
Lm/W



LIFUD
OSRAM LED
LUMILEDS

inoled

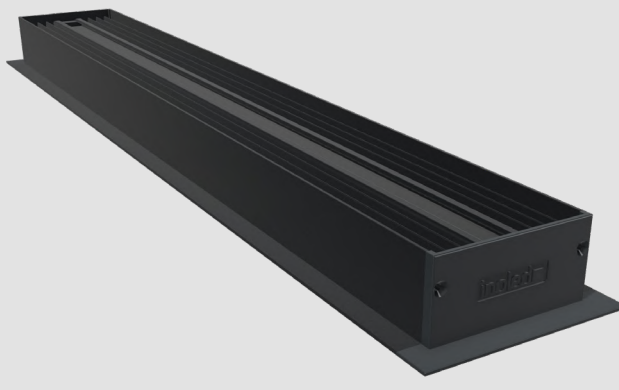

Sıva Altı Linear LED Armatürler Surface Mounted Linear LED Luminaire

Kod Code	Uzunluk Length	Kasa Ebatları Case Dimensions	Güç Power	Işık Rengi CCT			Işık Akısı Lumen	Adet/Koli Pcs/Carton	Fiyat Price
5326	60 cm	81 x 34 mm	18 W	01 6500K	02 3000K	03 4000K	2160 Lm	1	50,00 USD
5327	100 cm	81 x 34 mm	30 W	01 6500K	02 3000K	03 4000K	3600 Lm	1	69,00 USD
5328	120 cm	81 x 34 mm	36 W	01 6500K	02 3000K	03 4000K	4320 Lm	1	77,00 USD



- Polikarbon opal difüzör
 - Ürün kasaları istenilen RAL renk koduna göre üretilebilir
 - Ürünlerin farklı ölçüleri için opsiyonlarımız mevcuttur
- Lütfen iletişime geçiniz

Opsiyonlar

Ürün Kodu	Ürün Adı	Fiyat
9060	Askı Aparatı *	6,00 USD
9061	Lineer Tij takımı *	Fiyat Sorunuz
9062	Lineer Rozans	Fiyat Sorunuz
9063	Lineer Baza	Fiyat Sorunuz
9066	Tavan Aparatı	7,00 USD

*(1 Takım=2 Adet)

Opsiyonlar	DALI (1-10V) ACİL KİT
------------	--------------------------















LIFUD
OSRAM LED
LUMILEDS



Dekoratif LED Armatürler
Decorative Linear LED Luminaire

YUVARLAK SİMİT

Kod Code	Çap Diameter	Kasa Ebatları Case Dimensions	Güç Power	Işık Rengi CCT	Işık Akısı Lumen	Adet/Koli Pcs/Carton	Fiyat Price
5330	40 cm	80 x 75 mm	30 W	  	3600 Lm	1	153,00 USD
5331	60 cm	80 x 75 mm	50 W	  	6000 Lm	1	205,00 USD
5332	80 cm	80 x 75 mm	70 W	  	8400 Lm	1	279,00 USD
5333	100 cm	80 x 75 mm	90 W	  	10800 Lm	1	363,00 USD
5334	120 cm	80 x 75 mm	110 W	  	13200 Lm	1	449,00 USD
5335	150 cm	80 x 75 mm	140 W	  	16800 Lm	1	588,00 USD
5336	180 cm	80 x 75 mm	170 W	  	20400 Lm	1	711,00 USD

Opsiyonlar

DALI (1-10V)
ACİL KİT



PF
≥0,9

120
Lm/W



powered by
TRIDONIC
OSRAM LED

inoled

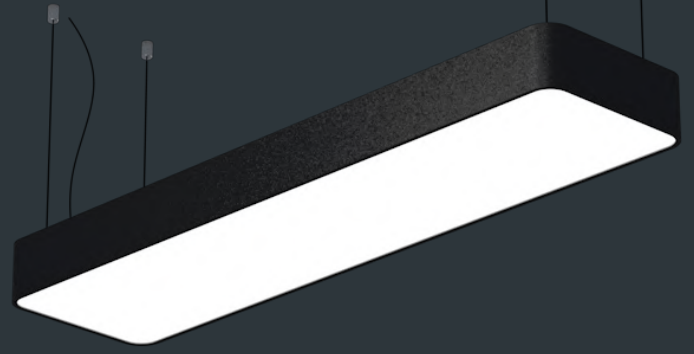

Dekoratif LED Armatürler
Decorative Linear LED Luminaire

YUVARLAK DAVUL

Kod Code	Çap Diameter	Kasa Ebatları Case Dimensions	Güç Power	Işık Rengi CCT	Işık Akısı Lumen	Adet/Koli Pcs/Carton	Fiyat Price
5340	40 cm	100 mm	25 W	01 6500K 02 3000K 03 4000K	3000 Lm	1	141,00 USD
5341	60 cm	100 mm	45 W	01 6500K 02 3000K 03 4000K	5400 Lm	1	218,00 USD
5342	80 cm	100 mm	90 W	01 6500K 02 3000K 03 4000K	10800 Lm	1	359,00 USD
5343	100 cm	100 mm	140 W	01 6500K 02 3000K 03 4000K	16800 Lm	1	514,00 USD
5344	120 cm	100 mm	200 W	01 6500K 02 3000K 03 4000K	24000 Lm	1	703,00 USD

Dekoratif Lineer LED Armatürler
Decorative Linear LED Luminaire

OVAL DİKDÖRTGEN DAVUL

Kod Code	Boy Size	Kasa Ebatları Case Dimensions	Güç Power	Işık Rengi CCT	Işık Akısı Lumen	Adet/Koli Pcs/Carton	Fiyat Price
5441	40 x 60 cm	100 mm	25 W	01 6500K 02 3000K 03 4000K	3000 Lm	1	165,00 USD
5443	200 x 100 cm	100 mm	42 W	01 6500K 02 3000K 03 4000K	5040 Lm	1	218,00 USD
5446	30 x 120 cm	100 mm	70 W	01 6500K 02 3000K 03 4000K	8400 Lm	1	292,00 USD

powered by
TRIDONIC
OSRAM LED

Opsiyonlar | DALI (1-10V)
ACİL KİT



PF
≥0,9

120
Lm/W



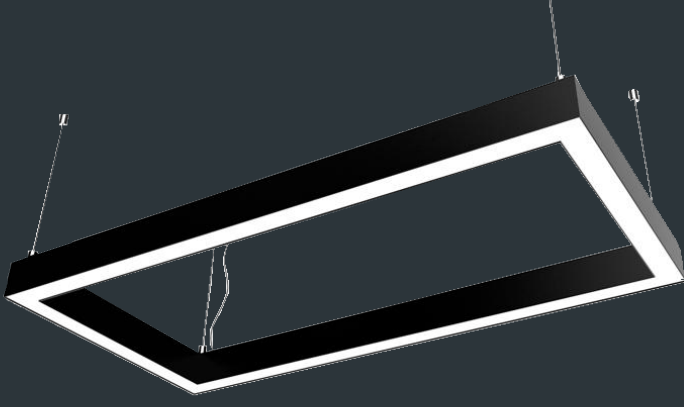

Dekoratif Lineer LED Armatürler Decorative Linear LED Luminaire

DİKDÖRTGEN SİMİT

Kod Code	Çap Diameter	Kasa Ebatları Case Dimensions	Güç Power	Işık Rengi CCT			Işık Akısı Lumen	Adet/Koli Pcs/Carton	Fiyat Price
5400	30 x 60 cm	80x50 mm	50 W	01 6500K	02 3000K	03 4000K	6000 Lm	1	150,00 USD
5401	60 x 120 cm	80x50 mm	105 W	01 6500K	02 3000K	03 4000K	12600 Lm	1	299,00 USD
5402	80 x 160 cm	80x50 mm	140 W	01 6500K	02 3000K	03 4000K	16800 Lm	1	399,00 USD
5403	100 x 200 cm	80x50 mm	180 W	01 6500K	02 3000K	03 4000K	21600 Lm	1	498,00 USD

Kod Code	Çap Diameter	Kasa Ebatları Case Dimensions	Güç Power	Işık Rengi CCT			Işık Akısı Lumen	Adet/Koli Pcs/Carton	Fiyat Price
5404	30 x 60 cm	66x35 mm	50 W	01 6500K	02 3000K	03 4000K	6000 Lm	1	142,00 USD
5405	60 x 120 cm	66x35 mm	105 W	01 6500K	02 3000K	03 4000K	12600 Lm	1	283,00 USD
5406	80 x 160 cm	66x35 mm	140 W	01 6500K	02 3000K	03 4000K	16800 Lm	1	377,00 USD
5407	100 x 200 cm	66x35 mm	180 W	01 6500K	02 3000K	03 4000K	21600 Lm	1	471,00 USD

powered by
TRIDONIC
OSRAM LED

Opsiyonlar

DALI (1-10V)
ACİL KİT



PF
≥0,9

120
Lm/W



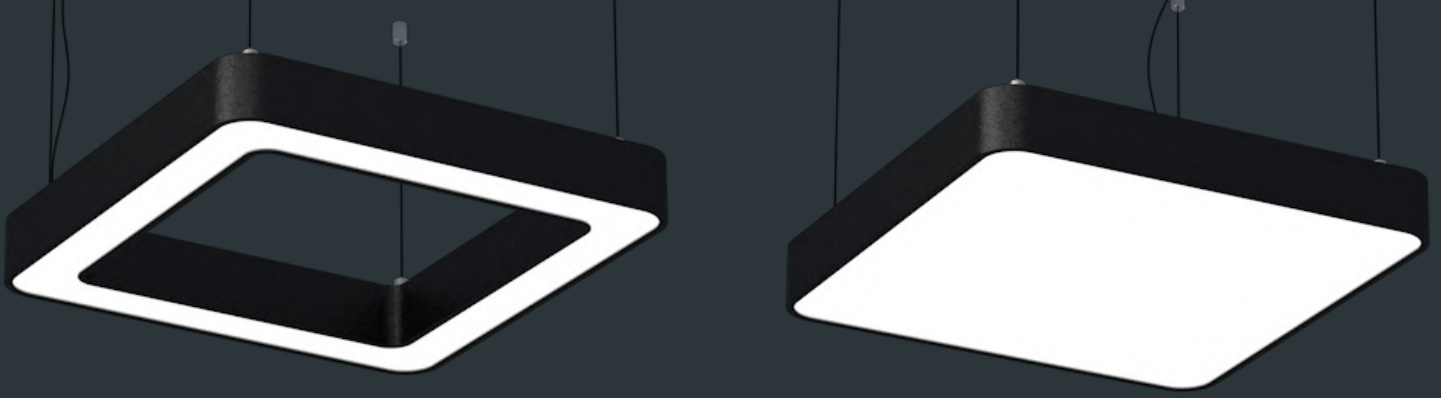

Dekoratif Lineer LED Armatürler
Decorative Linear LED Luminaire

OVAL KARE SİMİT

Kod Code	Boy Size	Kasa Ebatları Case Dimensions	Güç Power	Işık Rengi CCT	Işık Akısı Lumen	Adet/Koli Pcs/Carton	Fiyat Price
5470	40 cm	80 x 75 mm	50 W	01 6500K 02 3000K 03 4000K	6000 Lm	1	174,00 USD
5471	60 cm	80 x 75 mm	80 W	01 6500K 02 3000K 03 4000K	9600 Lm	1	252,00 USD
5472	90 cm	80 x 75 mm	120 W	01 6500K 02 3000K 03 4000K	14400 Lm	1	381,00 USD

Dekoratif Lineer LED Armatürler
Decorative Linear LED Luminaire

OVAL KARE DAVUL

Kod Code	Boy Size	Kasa Ebatları Case Dimensions	Güç Power	Işık Rengi CCT	Işık Akısı Lumen	Adet/Koli Pcs/Carton	Fiyat Price
5430	40 x 40 cm	100 mm	35 W	01 6500K 02 3000K 03 4000K	4200 Lm	1	157,00 USD
5431	60 x 60 cm	100 mm	75 W	01 6500K 02 3000K 03 4000K	9000 Lm	1	262,00 USD

powered by
TRIDONIC
OSRAM LED

Opsiyonlar	DALI (1-10V) ACİL KİT
------------	--------------------------



inoled

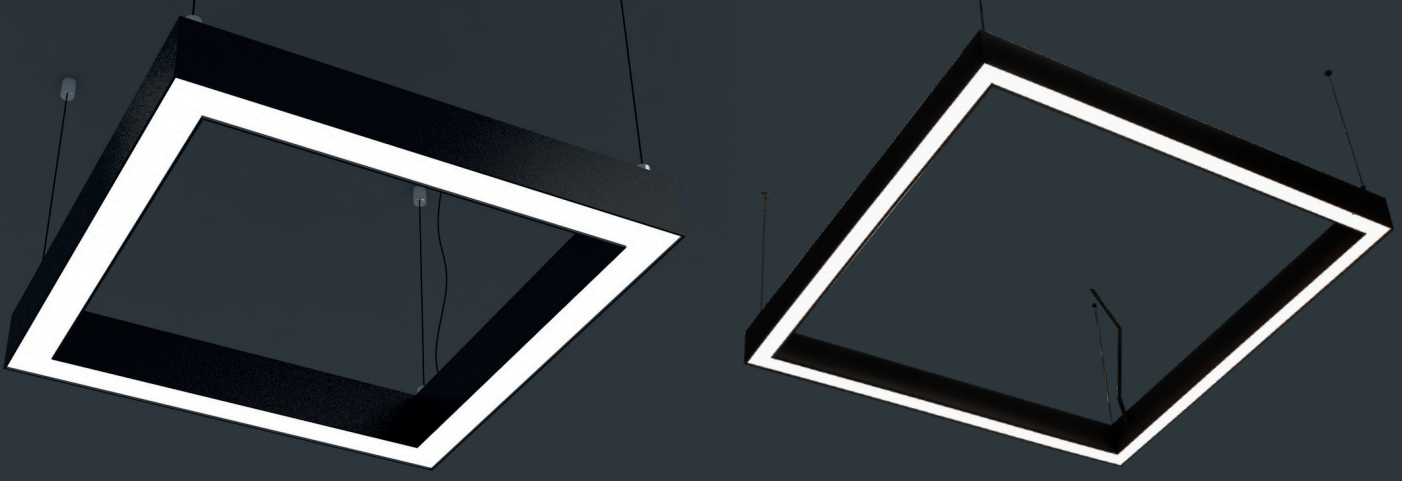

Dekoratif Lineer LED Armatürler
Decorative Linear LED Luminaire

KARE

Kod Code	Boy Size	Kasa Ebatları Case Dimensions	Güç Power	Işık Rengi CCT	Işık Akısı Lumen	Adet/Koli Pcs/Carton	Fiyat Price
5391	60 x 60 cm	80 x 50 mm	70 W	01 6500K 02 3000K 03 4000K	8400 Lm	1	200,00 USD
5392	80 x 80 cm	80 x 50 mm	95 W	01 6500K 02 3000K 03 4000K	11400 Lm	1	266,00 USD
5393	100 x 100 cm	80 x 50 mm	115 W	01 6500K 02 3000K 03 4000K	13800 Lm	1	332,00 USD
5394	120 x 120 cm	80 x 50 mm	140 W	01 6500K 02 3000K 03 4000K	16800 Lm	1	399,00 USD

Dekoratif Lineer LED Armatürler
Decorative Linear LED Luminaire

KARE

Kod Code	Boy Size	Kasa Ebatları Case Dimensions	Güç Power	Işık Rengi CCT	Işık Akısı Lumen	Adet/Koli Pcs/Carton	Fiyat Price
5395	60 x 60 cm	66 x 35 mm	70 W	01 6500K 02 3000K 03 4000K	8400 Lm	1	189,00 USD
5396	80 x 80 cm	66 x 35 mm	95 W	01 6500K 02 3000K 03 4000K	11400 Lm	1	251,00 USD
5397	100 x 100 cm	66 x 35 mm	115 W	01 6500K 02 3000K 03 4000K	13800 Lm	1	314,00 USD
5398	120 x 120 cm	66 x 35 mm	140 W	01 6500K 02 3000K 03 4000K	16800 Lm	1	377,00 USD

powered by
TRIDONIC
OSRAM LED

Opsiyonlar	DALI (1-10V) ACİL KİT
------------	--------------------------



inoled



Dekoratif Lineer LED Armatürler
Decorative Linear LED Luminaire

ELİPS

Kod Code	Boy Size	Kasa Ebatları Case Dimensions	Güç Power	Işık Rengi CCT			Işık Akısı Lumen	Adet/Koli Pcs/Carton	Fiyat Price
5480	30 x 90 cm	80 x 75 mm	55 W	01 6500K	02 3000K	03 4000K	6600 Lm	1	257,00 USD
5481	30 x 120 cm	80 x 75 mm	75 W	01 6500K	02 3000K	03 4000K	9000 Lm	1	326,00 USD
5482	60 x 120 cm	80 x 75 mm	85 W	01 6500K	02 3000K	03 4000K	10200 Lm	1	397,00 USD

Dekoratif Lineer LED Armatürler
Decorative Linear LED Luminaire

SU YOLU

Kod Code	Boy Size	Kasa Ebatları Case Dimensions	Güç Power	Işık Rengi CCT			Işık Akısı Lumen	Adet/Koli Pcs/Carton	Fiyat Price
5485	120 cm	80 x 75 mm	50 W	01 6500K	02 3000K	03 4000K	6000 Lm	1	185,00 USD
5486	150 cm	80 x 75 mm	60 W	01 6500K	02 3000K	03 4000K	7200 Lm	1	230,00 USD
5487	180 cm	80 x 75 mm	70 W	01 6500K	02 3000K	03 4000K	8400 Lm	1	267,00 USD

powered by
TRIDONIC
OSRAM LED

Opsiyonlar	DALI (1-10V) ACİL KİT
------------	--------------------------



inoled

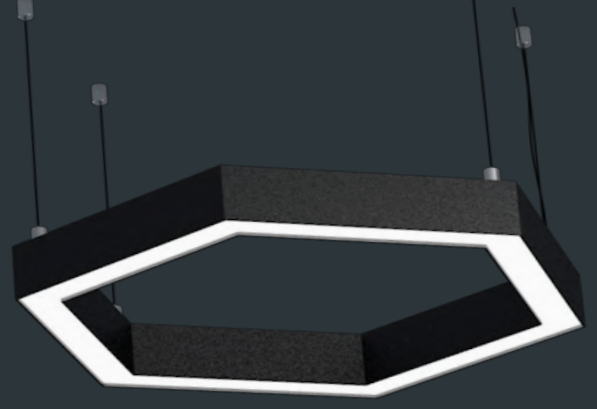
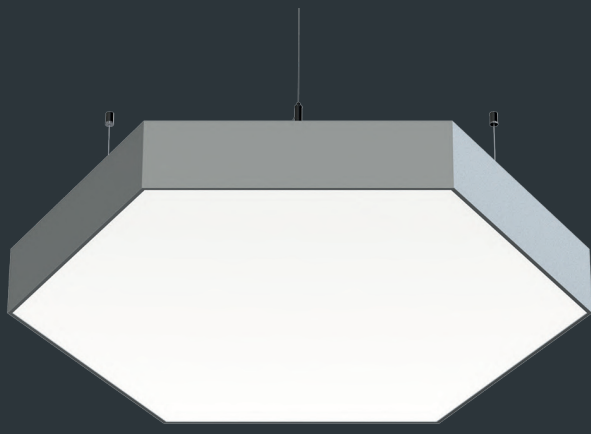

Dekoratif Lineer LED Armatürler Decorative Linear LED Luminaire

ALTIGEN DAVUL

Kod Code	Boy Size	Kasa Ebatları Case Dimensions	Güç Power	Işık Rengi CCT			Işık Akısı Lumen	Adet/Koli Pcs/Carton	Fiyat Price
5462	60 cm	100 mm	45 W	01 6500K	02 3000K	03 4000K	5400 Lm	1	262,00 USD
5465	90 cm	100 mm	110 W	01 6500K	02 3000K	03 4000K	13200 Lm	1	433,00 USD
5468	120 cm	100 mm	200 W	01 6500K	02 3000K	03 4000K	24000 Lm	1	724,00 USD

Dekoratif Lineer LED Armatürler Decorative Linear LED Luminaire

ALTIGEN

Kod Code	Boy Size	Kasa Ebatları Case Dimensions	Güç Power	Işık Rengi CCT			Işık Akısı Lumen	Adet/Koli Pcs/Carton	Fiyat Price
5411	6 x 30 cm	80x50 mm	50 W	01 6500K	02 3000K	03 4000K	6000 Lm	1	180,00 USD
5412	6 x 45 cm	80x50 mm	80 W	01 6500K	02 3000K	03 4000K	9600 Lm	1	268,00 USD
5413	6 x 60 cm	80x50 mm	105 W	01 6500K	02 3000K	03 4000K	12600 Lm	1	358,00 USD

powered by
TRIDONIC
OSRAM LED

Opsiyonlar | DALI (1-10V)
ACİL KİT



PF
≥0,9

120
Lm/W



inoled

RAVA

LED Wallwasher Armatür
LED Wallwasher Luminaire

3
YIL
GARANTİ

YENİ
ÜRÜN



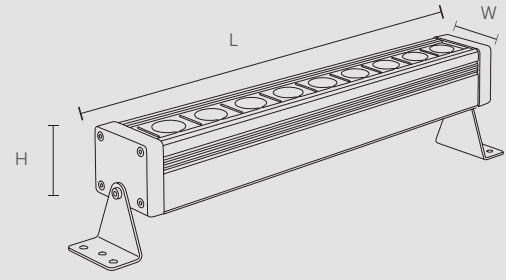
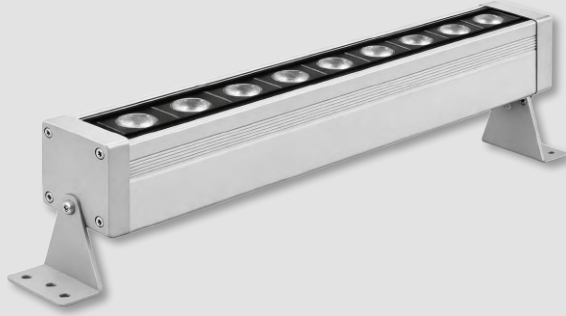

Kod Code	Güç Power	Boyutlar W x L x H	Işık Rengi CCT	Işık Akısı Lumen	Adet/Koli Pcs/Carton	Fiyat Price
5301	3 W	55 x 80 x 60 mm	01 6500K	300 Lm	10	24,00 USD
			02 3000K	300 Lm		
			03 Kırmızı	-		
			04 Yeşil	-		
			05 Mavi	-		
			07 4000K	300 Lm		
			08 Amber	-		
			5302	6 W		
02 3000K	600 Lm					
03 Kırmızı	-					
04 Yeşil	-	38,00 USD				
05 Mavi	-					
06 RGB	-					
07 4000K	600 Lm					
08 Amber	-	32,00 USD				
5303	9 W	55 x 240 x 60 mm	01 6500K	900 Lm	10	38,00 USD
			02 3000K	900 Lm		
			03 Kırmızı	-		
			04 Yeşil	-		47,00 USD
			05 Mavi	-		
			06 RGB	-		
			07 4000K	900 Lm		
			08 Amber	-		38,00 USD

Kod Code	Güç Power	Boyutlar W x L x H	Işık Rengi CCT	Işık Akısı Lumen	Adet/Koli Pcs/Carton	Fiyat Price
5304	12 W	55 x 320 x 60 mm	01 6500K	1200 Lm	10	45,00 USD
			02 3000K	1200 Lm		
			03 Kırmızı	-		
			04 Yeşil	-		
			05 Mavi	-		
			07 4000K	1200 Lm		
			08 Amber	-		
5305	18 W	55 x 480 x 60 mm	01 6500K	1800 Lm	10	59,00 USD
			02 3000K	1800 Lm		
			03 Kırmızı	-		
			04 Yeşil	-		66,00 USD
			05 Mavi	-		
			06 RGB	-		
			07 4000K	1800 Lm		
08 Amber	-	59,00 USD				
5306	24 W	55 x 640 x 60 mm	01 6500K	2400 Lm	10	72,00 USD
			02 3000K	2400 Lm		
			03 Kırmızı	-		
			04 Yeşil	-		
			05 Mavi	-		
			07 4000K	2400 Lm		
			08 Amber	-		
5307	36 W	55 x 960 x 60 mm	01 6500K	3600 Lm	10	90,00 USD
			02 3000K	3600 Lm		
			03 Kırmızı	-		
			04 Yeşil	-		105,00 USD
			05 Mavi	-		
			06 RGB	-		
			07 4000K	3600 Lm		
08 Amber	-	90,00 USD				

Solar Set Üstü Ürünler

Solar Post Light

Kod Code	Güç Power	Işık Rengi CCT	Işık Akısı Lumen	Adet/Koli Pcs/Carton	Fiyat Price
9311	30 W	 3CCT	270 Lm	10	31,00 USD



3000 / 4000 / 6500K
Ayarlanabilir Işık Rengi

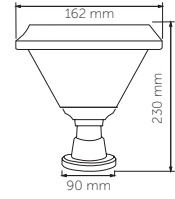

Şarj Süresi: 4~6 Saat Çalışma süresi: 8~12 Saat



3000 / 4000 / 6500K
Ayarlanabilir Işık Rengi

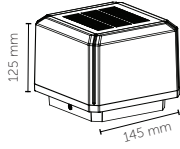

Kod Code	Güç Power	Işık Rengi CCT	Işık Akısı Lumen	Adet/Koli Pcs/Carton	Fiyat Price
9312	20 W	 3 CCT	270 Lm	18	38,00 USD

Şarj Süresi: 4~6 Saat Çalışma süresi: 10~12 Saat

Kod Code	Güç Power	Işık Rengi CCT	Işık Akısı Lumen	Adet/Koli Pcs/Carton	Fiyat Price
9313	30 W	 3 CCT	400 Lm	4	60,00 USD

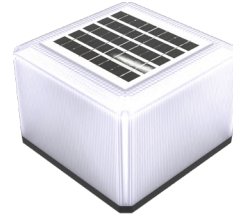

3000 / 4000 / 6500K
Ayarlanabilir Işık Rengi

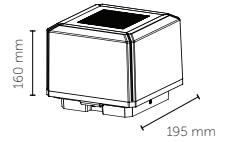

Şarj Süresi: 4~6 Saat Çalışma süresi: 10~12 Saat

Solar Çim

Solar Grass

Kod Code	Güç Power	Işık Rengi CCT	Işık Akısı Lumen	Adet/Koli Pcs/Carton	Fiyat Price
9303	10 W	 01 6500K	140 Lm	48	25,00 USD
		 02 3000K			
		 04 Yeşil			
		 08 Amber			

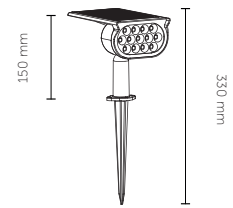

Şarj Süresi: 4~6 Saat Çalışma süresi: 8~10 Saat

Solar Aplik
Solar Applique

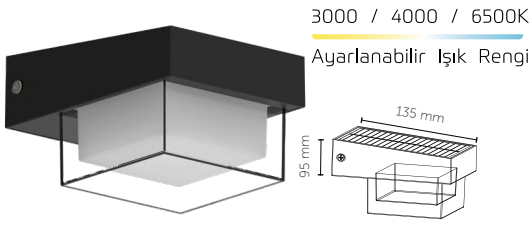

Kod Code	Güç Power	Işık Rengi CCT	Işık Akısı Lumen	Adet/Koli Pcs/Carton	Fiyat Price
9323	10 W	3 CCT	200 Lm	20	34,00 USD

Şarj Süresi: 4~6 Saat Çalışma süresi: 10~12 Saat

Kod Code	Güç Power	Işık Rengi CCT	Işık Akısı Lumen	Adet/Koli Pcs/Carton	Fiyat Price
9324	20 W	3 CCT	400 Lm	20	56,00 USD

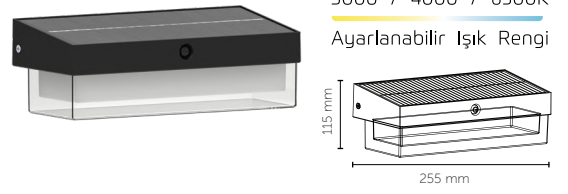

Şarj Süresi: 4~6 Saat Çalışma süresi: 10~12 Saat

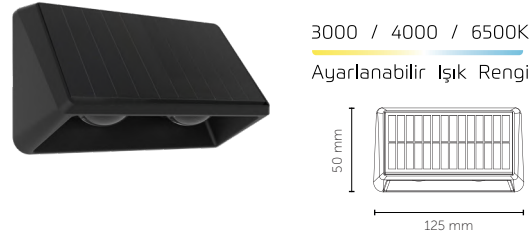

Kod Code	Güç Power	Işık Rengi CCT	Işık Akısı Lumen	Adet/Koli Pcs/Carton	Fiyat Price
9325	6 W	3 CCT	45 Lm	80	18,00 USD

Şarj Süresi: 4~6 Saat Çalışma süresi: 10~12 Saat

Kod Code	Güç Power	Işık Rengi CCT	Işık Akısı Lumen	Adet/Koli Pcs/Carton	Fiyat Price
9326	12 W	3 CCT	90 Lm	50	26,00 USD

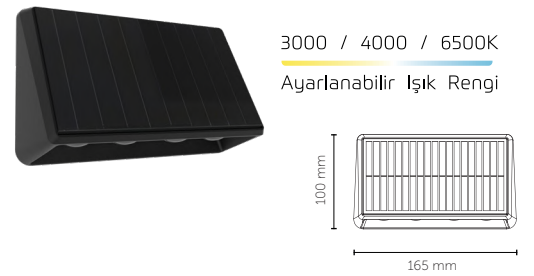

Şarj Süresi: 4~6 Saat Çalışma süresi: 10~12 Saat

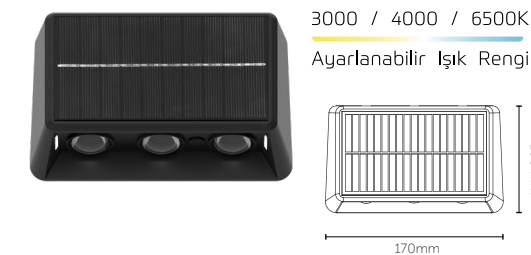

Kod Code	Güç Power	Işık Rengi CCT	Işık Akısı Lumen	Adet/Koli Pcs/Carton	Fiyat Price
9327	18 W	3 CCT	110 Lm	20	30,00 USD

Şarj Süresi: 4~6 Saat Çalışma süresi: 10~12 Saat

